



Stainless Steel Cylinder
Series CJ5-S/series CG5-S
ø10, ø16 ø20, ø25, ø32, ø40, ø50, ø63, ø80, ø100



For use in environments with water spray such as food processing machines

Stainless Steel Cylinder

Series **CJ5-S**/Series **CG5-S**

ø10, ø16

ø20, ø25, ø32, ø40, ø50, ø63, ø80, ø100

Uses grease for food processing machines that meets FDA (U.S. Food and Drug Administration) standards

The use of non-toxic additives allows confident use in equipment for **foods, beverages and medical products, etc.**

Special scraper (standard) prevents water from entering the cylinder.

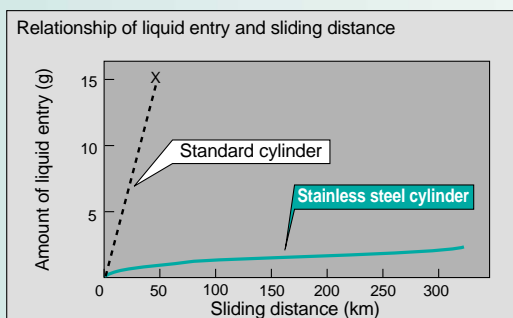

Conditions

Working fluid Air
Pressure 0.5MPa
Liquid Water-soluble coolant
Piston speed 200mm/sec (60cpm)

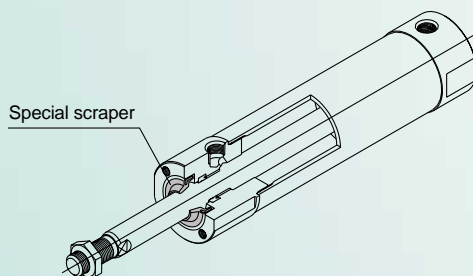
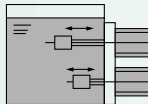

Two types of seal material

NBR or **FKM** can be selected to accommodate the application.
(Nitrile rubber) (Fluoro rubber)

Can be disassembled (Series **CG5-S**)
Replacement of seals promotes an extended service life.

(Before disassembly, be sure to see the section regarding maintenance under "Specific Product Precautions" on page 32.)

For use in environments with water spray such as food processing machines

All stainless steel specification (external parts)

Stainless steel (SUS304) is used for external metal parts. Corrosion resistance is improved even in environments with exposure to water.



Exterior configuration reduces residual liquid

- Electropolishing of mounting bracket surfaces makes them smoother to prevent build-up of liquids and foreign matter.
- Plugs are provided for unused mounting threads (Series CG5-S) to prevent residue build-up in the threads.

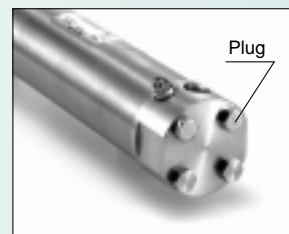

Series Variations

Series	Seal materials	Bore sizes (mm)										Applicable auto switches		
		10	16	20	25	32	40	50	63	80	100			
CJ5-S	NBR	●	●											Water resistant D-H7BAL
CG5-S	FKM			●	●	●	●	●	●	●	●	●		Water resistant D-G5BAL

Related Equipment

Water Resistant Air Cylinders	P. 18
Speed Controller with One-touch Fittings/Stainless Steel Series AS-FG	P. 20
One-touch Fittings/Stainless Steel Series KG	P. 21
Miniature Fittings MS	P. 25
Tubing T, TU	P. 26
Floating Joint/Stainless Steel Type JS	P. 27

Stainless Steel Cylinder

Series CJ5-S

ø10, ø16

How to Order

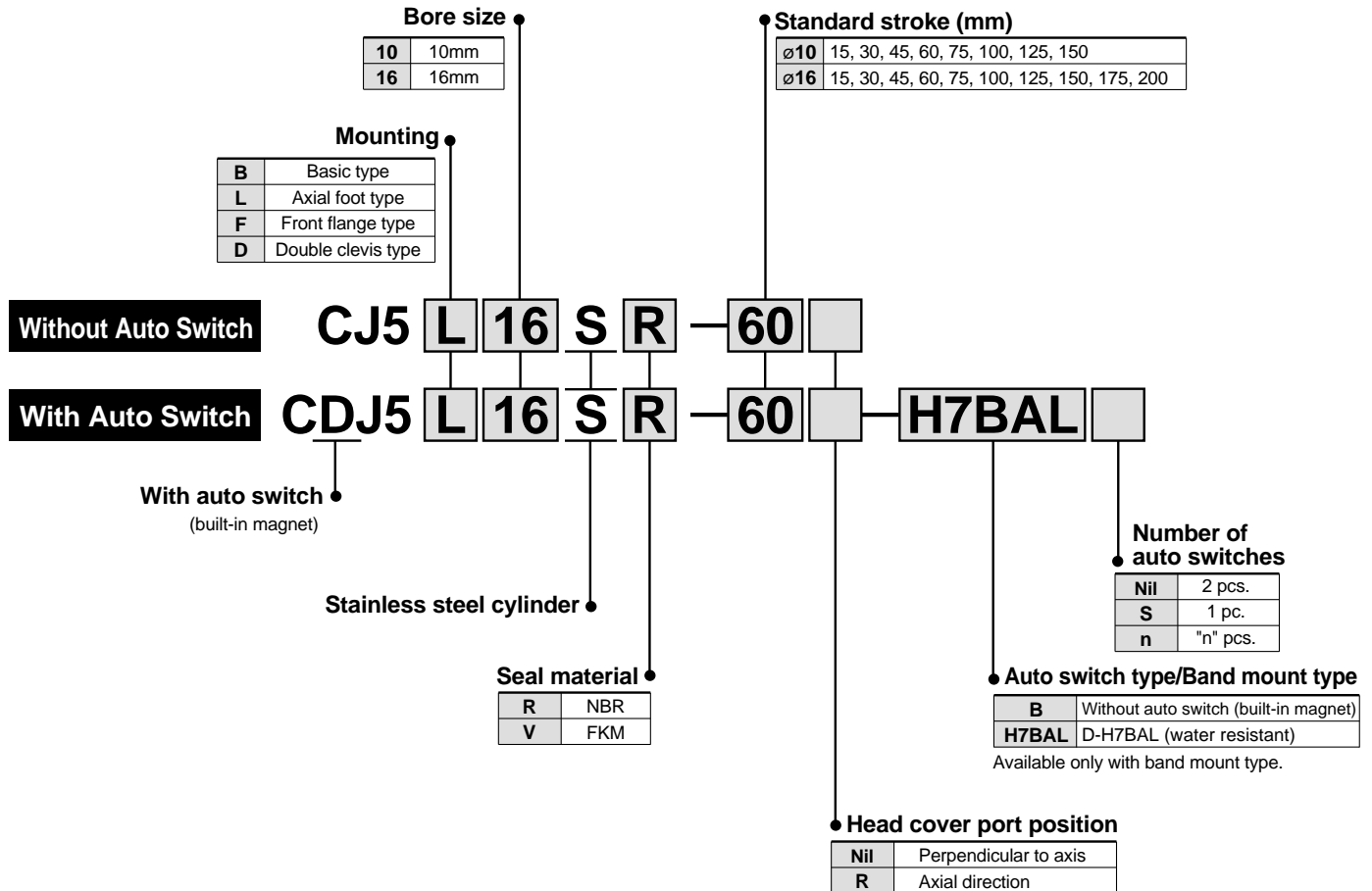

Mounting bracket part numbers

Mounting bracket	Bore size (mm)	
	10	16
Foot bracket	CJ-L016SUS	CJK-L016SUS
Flange bracket	CJ-F016SUS	CJK-F016SUS
T-bracket*	CJ-T010SUS	CJ-T016SUS

* The T-bracket is applicable to the double clevis type (D).

Auto switch mounting bracket part numbers (band mount type)

Bore size (mm)	Auto switch mounting bracket number	Note
10	BJ2-010S	Includes stainless steel mounting screws
16	BJ2-016S	

Grease pack for stainless steel cylinders/Part number: GR-R-010 (10g)

Auto switch specifications

Refer to pages 15 through 17 for auto switch related items.

D-H7BAL (with indicator light)/Band mount type	
Auto switch model	D-H7BAL
Wiring type	2 wire
Output type	—
Applicable load	24VDC Relay, PLC
Power supply voltage	—
Current consumption	—
Load voltage	24VDC (10 to 28VDC)
Load current	5 to 40mA
Internal voltage drop	4V or less
Leakage current	0.8mA or less at 24VDC
Indicator light	Actuated position Red LED lights up Optimum operating position ... Green LED lights up

Use caution during operation as residue may collect on auto switches.

Stainless Steel Cylinder **Series CJ5-S**

Specifications



JIS symbol

Double acting/Single rod

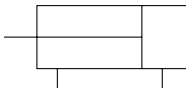

Action	Double acting single rod	
Fluid	Air	
Proof pressure	1.05MPa	
Maximum operating pressure	0.7MPa	
Minimum operating pressure	0.1MPa	
Ambient and fluid temperature	Without auto switch: -10 to 70°C, With auto switch: -10 to 60°C	
Cushion	Rubber bumper	
Lubrication	Not required (non-lube)	
Thread tolerance	JIS class 2	
Stroke length tolerance	+1.0 0	
Piston speed	50 to 750mm/s	
Allowable kinetic energy	∅10	0.035J
	∅16	0.090J
Mounting	Basic type, Axial foot type, Front flange type, Double clevis type	

Standard Strokes

(mm)

Bore size	Standard stroke
10	15, 30, 45, 60, 75, 100, 125, 150
16	15, 30, 45, 60, 75, 100, 125, 150, 175, 200

Mounting Types and Accessories

Mounting		Basic type	Axial foot type	Front flange type	Double clevis type*
Standard	Mounting nut	●	●	●	—
	Rod end nut	●	●	●	●
	Clevis pin	—	—	—	●
Optional	Single knuckle joint	●	●	●	●
	Double knuckle joint (with pin)*	●	●	●	●
	T-bracket	—	—	—	●
	Rod end cap	Flat type	●	●	●
Round type		●	●	●	●

* Pin and snap ring are packed together with double clevis and double knuckle joint.

Weights

(g)

Bore size (mm)		10	16
Standard weight*		52	96
Additional weight per 15mm of stroke		4	6.5
Mounting bracket weight	Axial foot type	22	22
	Front flange type	16	16
	Double clevis type (with pin)**	6	16

* The mounting nut and rod end nut are included in the basic weight.

** The mounting nut is not included with the double clevis type.

Calculation (Example) CJ5L10SR-45

- Basic weight 52 (∅10)
 - Additional weight 4/15mm stroke
 - Cylinder stroke 45mm
 - Mounting bracket weight ... 22 (axial foot type)
- 52 + 4/15 x 45 + 22 = 86g

Series CJ5-S

Construction (Cannot be disassembled)

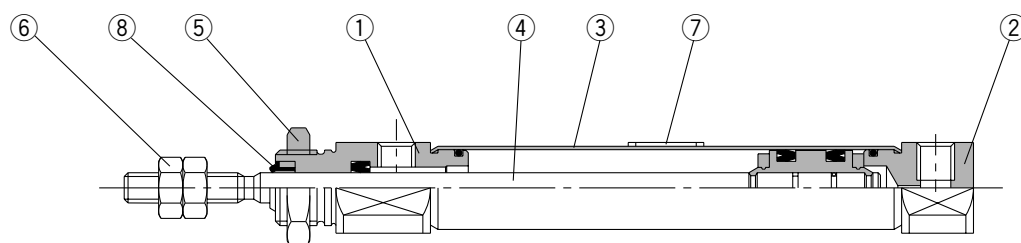

Parts list

No.	Description	Material	
1	Rod cover	SUS304	
2	Head cover	SUS304	
3	Cylinder tube	SUS304	
4	Piston rod	SUS304	
5	Mounting nut	SUS304	
6	Rod end nut	SUS304	
7	Label protector	PET	
8	Water resistant scraper	CJ5□□SR	NBR
		CJ5□□SV	FKM

Dimensions

Basic type (B)/C□J5B□S^R_V

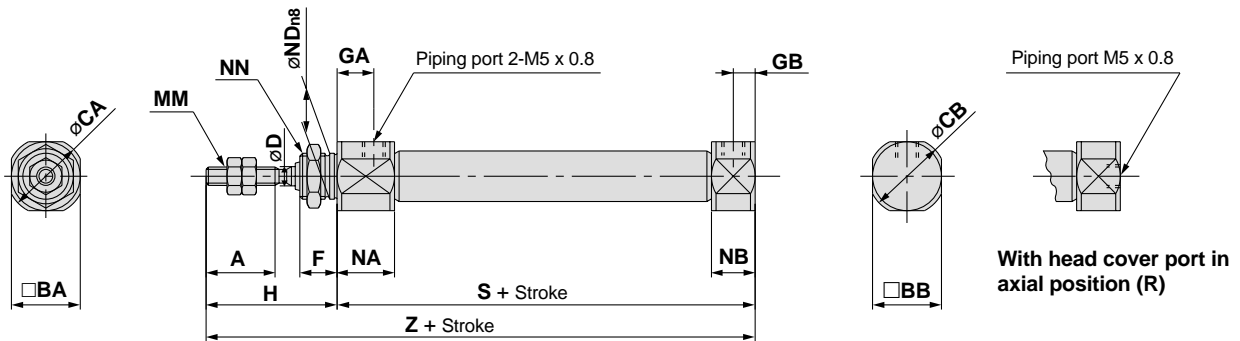

Bore size (mm)	A	BA	BB	CA	CB	D	F	GA	GB	H	MM	NN	NA	NB	NDn8	S	Z
10	15	15	12	17	14	4	8	8	5	28	M4 x 0.7	M10 x 1.0	12.5	9.5	10 ⁰ _{-0.022}	46	74
16	15	18	18	20	20	5	8	8	5	28	M5 x 0.8	M12 x 1.0	12.5	9.5	12 ⁰ _{-0.027}	47	75

Axial foot type (L)/C□J5L□S^R_V

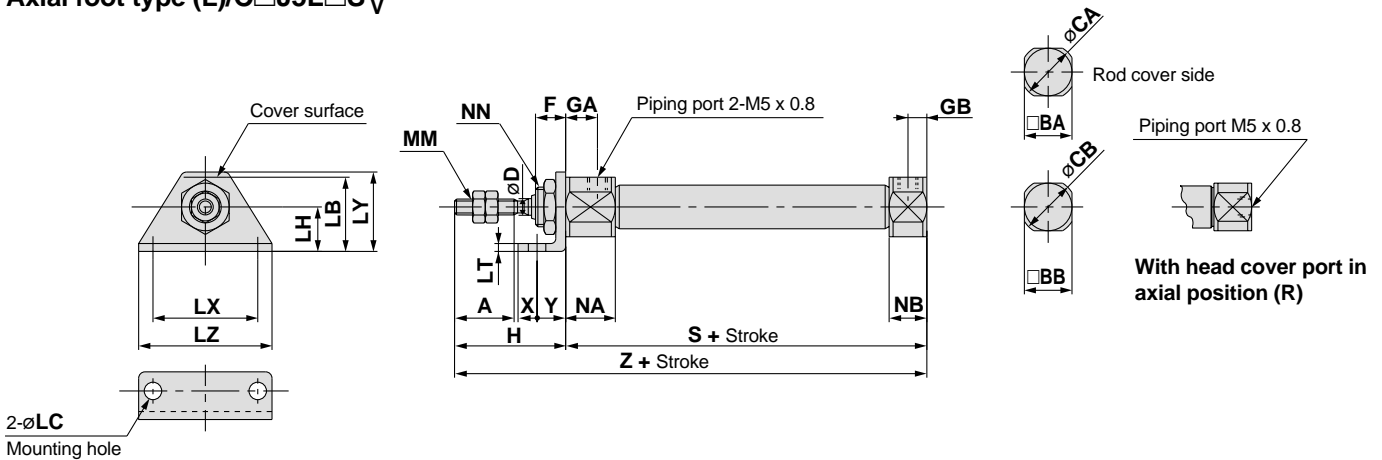

Bore size (mm)	A	BA	BB	CA	CB	D	F	GA	GB	H	LB	LC	LH	LT	LX	LY	LZ	MM	NN	NA	NB	S	X	Y	Z
10	15	15	12	17	14	4	8	8	5	28	21.5	5.5	14	2.5	33	25	42	M4 x 0.7	M10 x 1.0	12.5	9.5	46	6	9	74
16	15	18	18	20	20	5	8	8	5	28	23	5.5	14	2.5	33	25	42	M5 x 0.8	M12 x 1.0	12.5	9.5	47	6	9	75

Series CJ5-S

Dimensions

Front flange type (F)/C□J5F□S^R_V

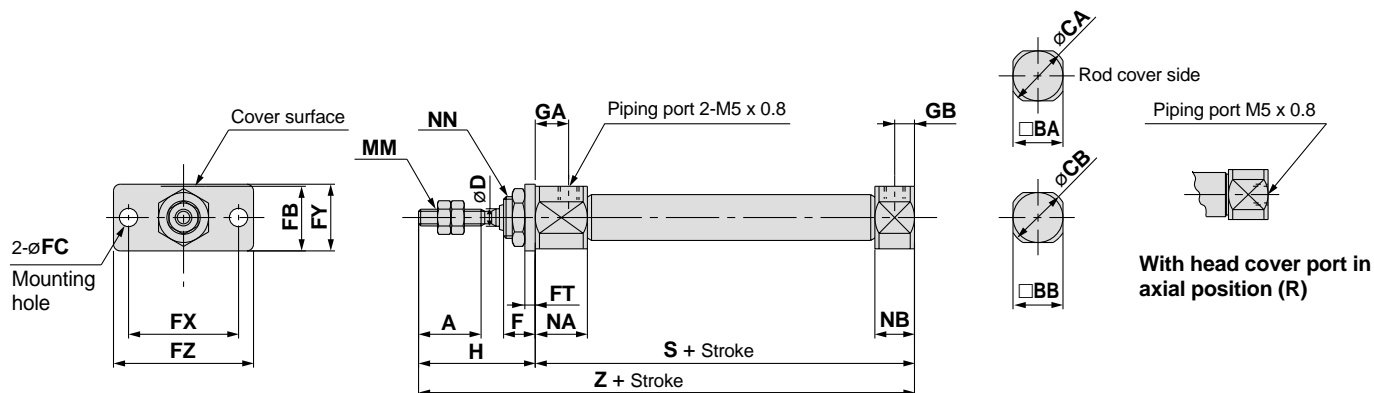

																					(mm)	
Bore size (mm)	A	BA	BB	CA	CB	D	F	FB	FC	FT	FX	FY	FZ	GA	GB	H	MM	NN	NA	NB	S	Z
10	15	15	12	17	14	4	8	17.5	5.5	2.5	33	20	42	8	5	28	M4 x 0.7	M10 x 1.0	12.5	9.5	46	74
16	15	18	18	20	20	5	8	19	5.5	2.5	33	20	42	8	5	28	M5 x 0.8	M12 x 1.0	12.5	9.5	47	75

Double clevis type (D)/C□J5D□S^R_V

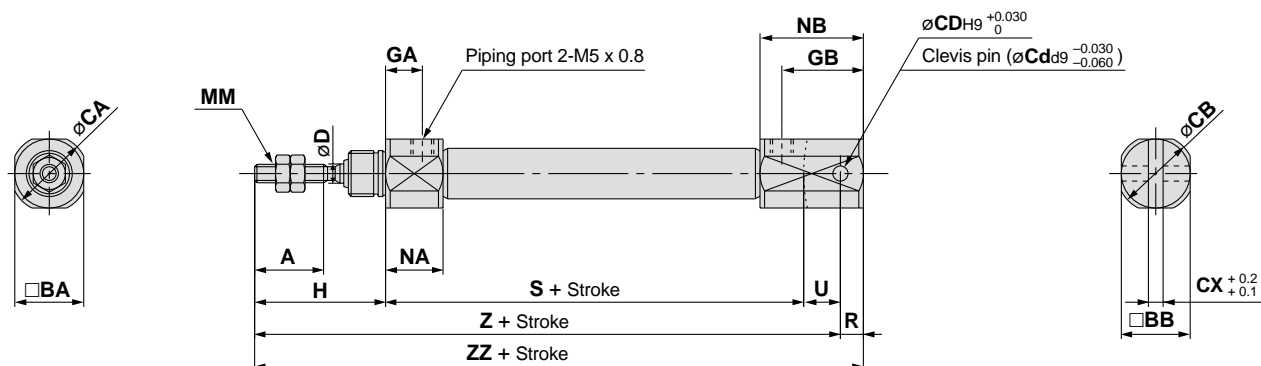

																					(mm)	
Bore size (mm)	A	BA	BB	CA	CB	CD (Cd)	CX	D	GA	GB	H	MM	NA	NB	R	S	U	Z	ZZ			
10	15	15	12	17	14	3.3	3.2	4	8	18	28	M4 x 0.7	12.5	22.5	5	46	8	82	87			
16	15	18	18	20	20	5	6.5	5	8	23	28	M5 x 0.8	12.5	27.5	8	47	10	85	93			

* Clevis pin and snap ring are packed together.

Accessory Dimensions

Single knuckle joint

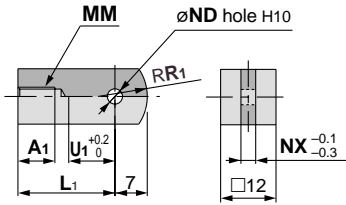

Material: SUS304

Part no.	Applicable bore size (mm)	A1	L1	MM	NDH10	NX	R1	U1
I-J010SUS	10	8	21	M4 x 0.7	3.3 $\begin{smallmatrix} +0.048 \\ 0 \end{smallmatrix}$	3.1	8	9
I-J016SUS	16	8	25	M5 x 0.8	5 $\begin{smallmatrix} +0.048 \\ 0 \end{smallmatrix}$	6.4	12	14

Clevis pin

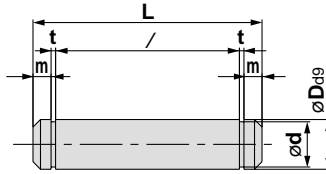

Material: Pin and snap ring both SUS304

Part no.	Applicable bore size (mm)	Dd9	d	L	/	m	t	Snap ring
CD-J010	10	3.3 $\begin{smallmatrix} -0.030 \\ -0.060 \end{smallmatrix}$	3	15.2	12.2	1.2	0.3	C type 3.2
CD-Z015SUS	16	5 $\begin{smallmatrix} -0.030 \\ -0.060 \end{smallmatrix}$	4.8	22.7	18.3	1.5	0.7	C type 5

Knuckle pin

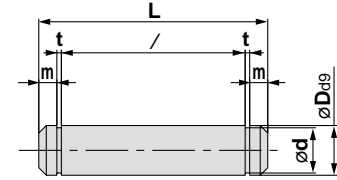

Material: Pin and snap ring both SUS304

Part no.	Applicable bore size (mm)	Dd9	d	L	/	m	t	Snap ring
CD-J010	10	3.3 $\begin{smallmatrix} -0.030 \\ -0.060 \end{smallmatrix}$	3	15.2	12.2	1.2	0.3	C type 3.2
IY-J015SUS	16	5 $\begin{smallmatrix} -0.030 \\ -0.060 \end{smallmatrix}$	4.8	16.6	12.2	1.5	0.7	C type 5

Double knuckle joint

* Knuckle pin and snap ring are packed together.

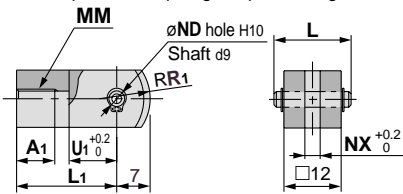

Material: SUS304

Part no.	Applicable bore size (mm)	A1	L	L1	MM	NDø9
Y-J010SUS	10	8	15.2	21	M4 x 0.7	3.3 $\begin{smallmatrix} -0.030 \\ -0.060 \end{smallmatrix}$
Y-J016SUS	16	11	16.6	21	M5 x 0.8	5 $\begin{smallmatrix} -0.030 \\ -0.060 \end{smallmatrix}$

Part no.	NDH10	NX	R1	U1
Y-J010SUS	3.3 $\begin{smallmatrix} +0.048 \\ 0 \end{smallmatrix}$	3.2	8	10
Y-J016SUS	5 $\begin{smallmatrix} +0.048 \\ 0 \end{smallmatrix}$	6.5	12	10

Mounting nut

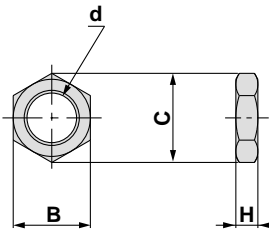

Material: SUS304

Part no.	Applicable bore size (mm)	B	C	d	H
SNJ-016SUS	10	14	16.2	M10 x 1.0	4
SNKJ-016SUS	16	17	19.6	M12 x 1.0	4

Rod end nut

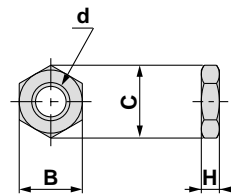

Material: SUS304

Part no.	Applicable bore size (mm)	B	C	d	H
NTJ-010SUS	10	7	8.1	M4 x 0.7	3.2
NTJ-015SUS	16	8	9.2	M5 x 0.8	4

T-bracket

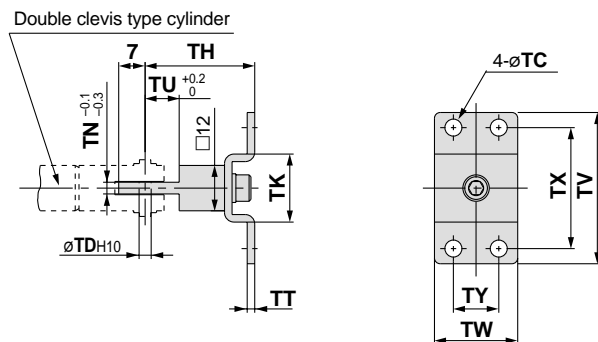

Material: SUS304

Part no.	Applicable bore size (mm)	TC	TDH10	TH	TK	TN	TT	TU	TV	TW	TX	TY
CJ-T010SUS	10	4.5	3.3 $\begin{smallmatrix} +0.048 \\ 0 \end{smallmatrix}$	29	18	3.1	2	9	40	22	32	12
CJ-T016SUS	16	5.5	5 $\begin{smallmatrix} +0.048 \\ 0 \end{smallmatrix}$	35	20	6.4	2.5	14	48	28	38	16

Rod end cap

Flat type/CJ-CF□□□

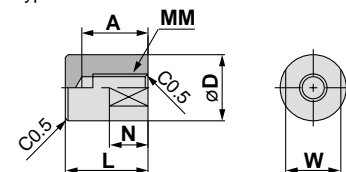

Round type/CJ-CR□□□

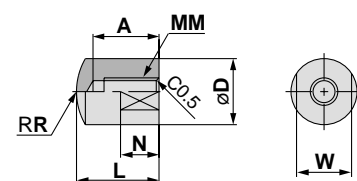

Material: POM

Part no.	Applicable bore size (mm)	A	D	L	MM	N	R	W	
CJ-CF010	CJ-CR010	10	8	10	13	M4 x 0.7	6	10	8
CJ-CF016	CJ-CR016	16	10	12	15	M5 x 0.8	7	12	10

Stainless Steel Cylinder

Series CG5-S

Ø20, Ø25, Ø32, Ø40, Ø50, Ø63, Ø80, Ø100

How to Order

Without Auto Switch

CG5 L N 25 S R 100

With Auto Switch

CDG5 L N 25 S R 100 G5BAL

With auto switch
(built-in magnet)

Mounting

B	Basic type
L	Axial foot type
F	Front flange type
G	Rear flange type
E	Integral clevis type

Type

N	Non-lube, rubber bumper
A	Non-lube, air cushion

Bore size

20	20mm	50	50mm
25	25mm	63	63mm
32	32mm	80	80mm
40	40mm	100	100mm

Number of auto switches

Nil	2 pcs.
S	1 pc.
n	"n" pcs.

Auto switch type/Band mount type

Nil	Without auto switch (built-in magnet)
G5BAL	D-G5BAL (water resistant)

Auto switches are available in the band mount type only.

Cylinder stroke (mm)

Refer to the standard stroke table on page 8.

Seal material

R	NBR
V	FKM

Stainless steel cylinder

Mounting bracket part numbers

Mounting bracket	Bore size (mm)							
	20	25	32	40	50	63	80	100
Axial foot <small>Note 1)</small>	CG-L020SUS	CG-L025SUS	CG-L032SUS	CG-L040SUS	CG-L050SUS	CG-L063SUS	CG-L080SUS	CG-L100SUS
Flange	CG-F020SUS	CG-F025SUS	CG-F032SUS	CG-F040SUS	CG-F050SUS	CG-F063SUS	CG-F080SUS	CG-F100SUS
Trunnion bracket <small>Note 2)</small>	CG-E020SUS		CG-E032SUS		CG-E050SUS		CG-E080SUS	

Note 1) Order two foot brackets for each cylinder.

Note 2) Includes clevis pin and snap ring.

Auto switch mounting bracket part numbers (band mount type)

Auto switch model	Bore size (mm)							
	20	25	32	40	50	63	80	100
D-G5BAL	NBA-088S	NBA-106S	BGS1-032S	BAF-04S	BAF-05S	BAF-06S	BAF-08S	BAF-10S

* Includes stainless steel mounting screws.

Auto switch specifications

Refer to pages 15 through 17 for auto switch related items.

D-G5BAL (With indicator light)/Band mount type	
Auto switch model	D-G5BAL
Wiring type	2 wire
Output type	—
Applicable load	24VDC relay, PLC
Power supply voltage	—
Current consumption	—
Load voltage	24VDC (10 to 28VDC)
Load current	5 to 40mA
Internal voltage drop	4V or less
Leakage current	0.8mA or less at 24VDC
Indicator light	Actuated position Red LED lights up Optimum operating position ... Green LED lights up

Use caution during operation as residue may collect on auto switches.

Grease pack for stainless steel cylinders/Part number: GR-R-010 (10g)

Stainless Steel Cylinder **Series CG5-S**

Specifications



JIS symbol
Double acting/Single rod

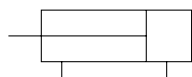

Minimum stroke for mounting auto switches

Model	Number of auto switches	
	2 pcs.	1 pc.
D-G5BAL	15mm	10mm

Refer to page 15 for details.

Action	Double acting single rod	
Fluid	Air	
Proof pressure	1.5MPa	
Maximum operating pressure	1.0MPa	
Minimum operating pressure	0.05MPa	
Ambient and fluid temperature	Without auto switch: -10 to 70°C, With auto switch: -10 to 60°C	
Cushion	Rubber bumper, Air cushion	
Piston speed	ø20 to ø63	50 to 1000mm/s
	ø80, ø100	50 to 700mm/s
Thread tolerance	JIS class 2	
Stroke length tolerance	ø20 to ø63	to 1000 ^{+1.4} ₀ mm, to 1200 ^{+1.5} ₀ mm
	ø80, ø100	to 1000 ^{+1.4} ₀ mm, to 1500 ^{+1.5} ₀ mm
Mounting	Basic type, Axial foot type, Front flange type, Rear flange type, Integral clevis type	

Standard Strokes

(mm)

Bore size	Standard stroke ^{Note 1)}	Long stroke
20	25, 50, 75, 100, 125, 150, 200	201 to 350
25	25, 50, 75, 100, 125, 150, 200, 250, 300	301 to 400
32		301 to 450
40		301 to 800
50, 63		301 to 1200
80		301 to 1400
100		301 to 1500

Note 1) All non-standard strokes are produced upon receipt of order. (Spacers are not used on intermediate strokes.)

Accessories

Mounting		Basic type	Axial foot type	Front flange type	Rear flange type	Integral clevis type
Standard	Rod end nut	●	●	●	●	●
Optional	Single knuckle joint	●	●	●	●	●
	Double knuckle joint (with pin & snap ring)	●	●	●	●	●
	Trunnion bracket (with pin & snap ring)	—	—	—	—	●

Weights

(kg)

Bore size		20	25	32	40	50	63	80	100
Standard weight	Basic type	0.32	0.42	0.61	0.97	1.78	2.73	5.20	8.13
	Axial foot type	0.40	0.53	0.72	1.13	2.12	3.19	5.91	9.50
	Flange type	0.43	0.53	0.71	1.12	2.04	3.25	5.86	9.29
	Integral clevis type	0.37	0.48	0.72	1.12	2.17	3.26	6.48	9.94
Trunnion bracket		0.08	0.08	0.18	0.18	0.46	0.46	1.65	1.65
Single knuckle joint		0.04	0.07	0.07	0.11	0.22	0.22	0.53	0.78
Double knuckle joint (with pin)		0.05	0.09	0.09	0.18	0.33	0.33	0.73	1.07
Additional weight per 50mm of stroke		0.06	0.08	0.14	0.18	0.27	0.33	0.50	0.73
Additional weight with air cushion		0.02	0.02	0.03	0.02	0.06	0.07	0.14	0.16

Calculation (Example) CG5LA 20SR-100
(Foot type ø20, 100mm stroke)

- Basic weight 0.40kg (Foot type ø20)
 - Additional stroke weight 0.06kg/50mm stroke
 - Air cylinder stroke 100mm
 - Additional air cushion weight 0.02kg
- 0.40 + 0.06 x 100/50 + 0.02 = 0.54kg

Series CG5-S

Construction

With rubber bumper

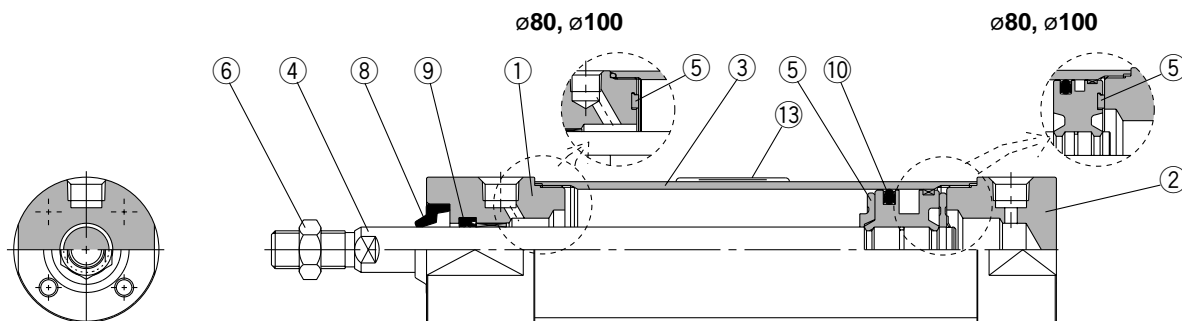

With air cushion

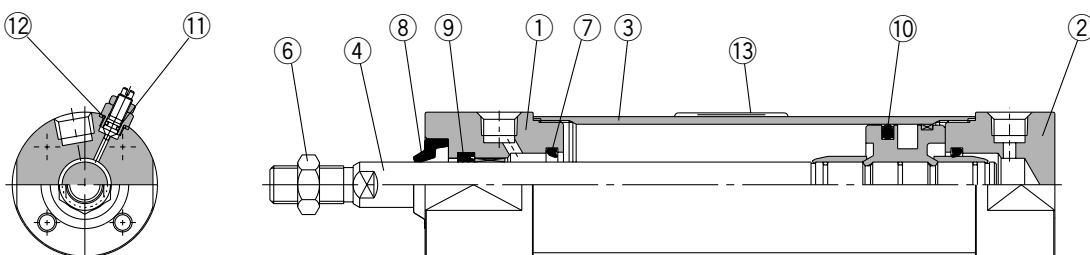

Parts list

No.	Description	Material
1	Rod cover	SUS304
2	Head cover	SUS304
3	Cylinder tube	SUS304
4	Piston rod	SUS304
5	Bumper	Urethane
6	Rod end nut	SUS304
7	Cushion seal	Urethane

Note) Magnets are installed on pistons of cylinders equipped with auto switches.

No.	Description	Material	
		CG5□□□SR	CG5□□□SV
8	Water resistant scraper	NBR	FKM
9	Rod seal		
10	Piston seal		
11	Valve seal		
12	Valve retainer gasket		
13	Label protector	PET	

Replacement parts: Seal kits Note)

Bore size	Rubber bumper		Air cushion	
	CG5□□□SR	CG5□□□SV	CG5□□□SR	CG5□□□SV
20	CG5N20SR-PS	CG5N20SV-PS	CG5A20SR-PS	CG5A20SV-PS
25	CG5N25SR-PS	CG5N25SV-PS	CG5A25SR-PS	CG5A25SV-PS
32	CG5N32SR-PS	CG5N32SV-PS	CG5A32SR-PS	CG5A32SV-PS
40	CG5N40SR-PS	CG5N40SV-PS	CG5A40SR-PS	CG5A40SV-PS
50	CG5N50SR-PS	CG5N50SV-PS	CG5A50SR-PS	CG5A50SV-PS
63	CG5N63SR-PS	CG5N63SV-PS	CG5A63SR-PS	CG5A63SV-PS
80	CG5N80SR-PS	CG5N80SV-PS	CG5A80SR-PS	CG5A80SV-PS
100	CG5N100SR-PS	CG5N100SV-PS	CG5A100SR-PS	CG5A100SV-PS
Contents	Nos. 9 and 10 above		Nos. 9, 10, 11 and 12 above	

Note) A grease pack (GR-R-010, 10g) is included in seal kits.

Dimensions

Basic type (B)/C□G5BN□S^R: With rubber bumper

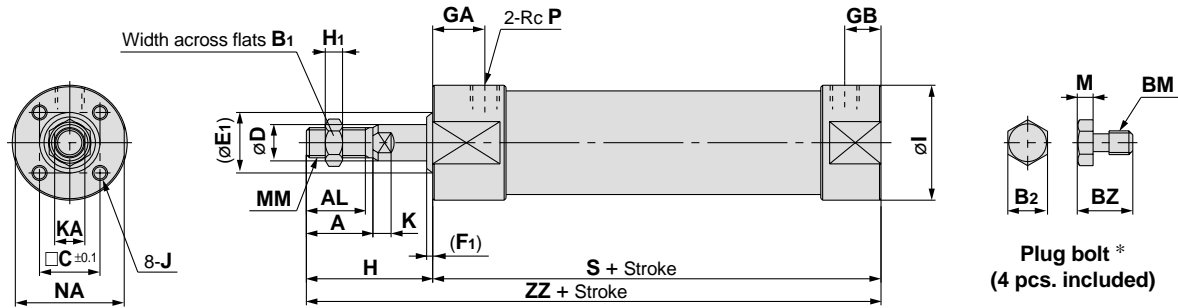

Bore size (mm)	Stroke range	A	AL	B ₁	B ₂	BM	BZ	C	D	E ₁	F ₁	GA	GB	H	H ₁	I	J	K	KA	M	MM	NA	P	S	ZZ
20	to 350	18	15.5	13	7	M4 x 0.7	9	16.5	8	15	3	18	12	35	5	31	M4 x 0.7 depth 7	5	6	3	M8 x 1.25	29	1/8	83	118
25	to 400	22	19.5	17	8	M5 x 0.8	9.5	18.5	10	17	3	18	12	40	6	33	M5 x 0.8 depth 8	5.5	8	3.5	M10 x 1.25	29	1/8	83	123
32	to 450	22	19.5	17	8	M5 x 0.8	9.5	20	12	19	3	18	12	40	6	38	M5 x 0.8 depth 8	5.5	10	3.5	M10 x 1.25	35.5	1/8	85	125
40	to 800	30	27	19	10	M6 x 1.0	12	26	16	23	3	19	13	50	8	47	M6 x 1.0 depth 12	6	14	4	M14 x 1.5	44	1/8	93	143
50	to 1200	35	32	27	13	M8 x 1.25	15.5	32	20	28	3	21	14	58	11	58	M8 x 1.25 depth 16	7	18	5.5	M18 x 1.5	55	1/4	109	167
63	to 1200	35	32	27	17	M10 x 1.5	19	38	20	28	3	21	14	58	11	72	M10 x 1.5 depth 16	7	18	7	M18 x 1.5	69	1/4	109	167
80	to 1400	40	37	32	17	M10 x 1.5	19	50	25	33	3	28	20	71	13	89	M10 x 1.5 depth 22	10	22	7	M22 x 1.5	80	3/8	130	201
100	to 1500	40	37	41	19	M12 x 1.75	24	60	30	38	3	29	20	71	16	110	M12 x 1.75 depth 23	10	26	8	M26 x 1.5	100	1/2	131	202

* Install plug bolts, which are included, in any unused mounting holes.

Basic type (B)/C□G5BA□S^R: With air cushion

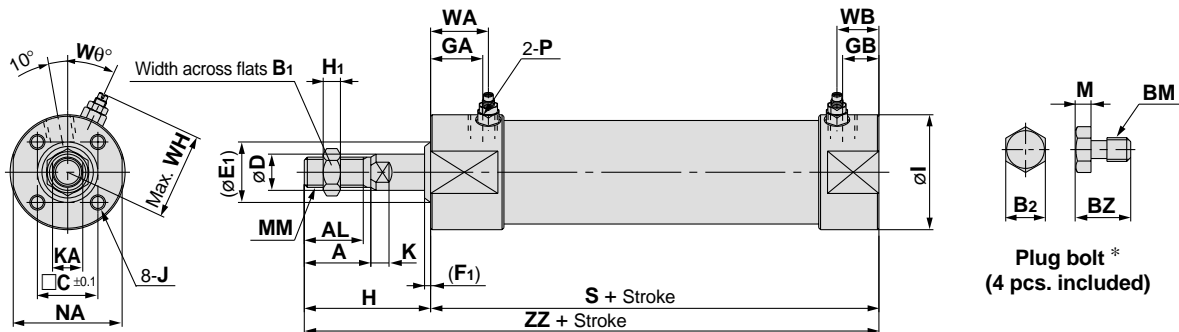

Bore size (mm)	Stroke range	A	AL	B ₁	B ₂	BM	BZ	C	D	E ₁	F ₁	GA	GB	H	H ₁	I	J	K	KA	M	MM	NA	P	S
20	to 350	18	15.5	13	7	M4 x 0.7	9	16.5	8	15	3	18	12	35	5	31	M4 x 0.7 depth 7	5	6	3	M8 x 1.25	29	M5 x 0.8	83
25	to 400	22	19.5	17	8	M5 x 0.8	9.5	18.5	10	17	3	18	12	40	6	33	M5 x 0.8 depth 8	5.5	8	3.5	M10 x 1.25	29	M5 x 0.8	83
32	to 450	22	19.5	17	8	M5 x 0.8	9.5	20	12	19	3	18	12	40	6	38	M5 x 0.8 depth 8	5.5	10	3.5	M10 x 1.25	35.5	Rc 1/8	85
40	to 800	30	27	19	10	M6 x 1.0	12	26	16	23	3	19	13	50	8	47	M6 x 1.0 depth 12	6	14	4	M14 x 1.5	44	Rc 1/8	93
50	to 1200	35	32	27	13	M8 x 1.25	15.5	32	20	28	3	21	14	58	11	58	M8 x 1.25 depth 16	7	18	5.5	M18 x 1.5	55	Rc 1/4	109
63	to 1200	35	32	27	17	M10 x 1.5	19	38	20	28	3	21	14	58	11	72	M10 x 1.5 depth 16	7	18	7	M18 x 1.5	69	Rc 1/4	109
80	to 1400	40	37	32	17	M10 x 1.5	19	50	25	33	3	28	20	71	13	89	M10 x 1.5 depth 22	10	22	7	M22 x 1.5	80	Rc 3/8	130
100	to 1500	40	37	41	19	M12 x 1.75	24	60	30	38	3	29	20	71	16	110	M12 x 1.75 depth 23	10	26	8	M26 x 1.5	100	Rc 1/2	131

* Install plug bolts, which are included, in any unused mounting holes.

Bore size (mm)	WA	WB	WH	Wθ	ZZ
20	22	16	23	30°	118
25	22	16	25	30°	123
32	22	16	28.5	25°	125
40	22	16	33	20°	143
50	25	18	40.5	20°	167
63	25	18	47.5	20°	167
80	30	22	60.5	20°	201
100	31	22	71	20°	202

Series CG5-S

Dimensions

Axial foot type (L)/C□G5LN□S_V^R

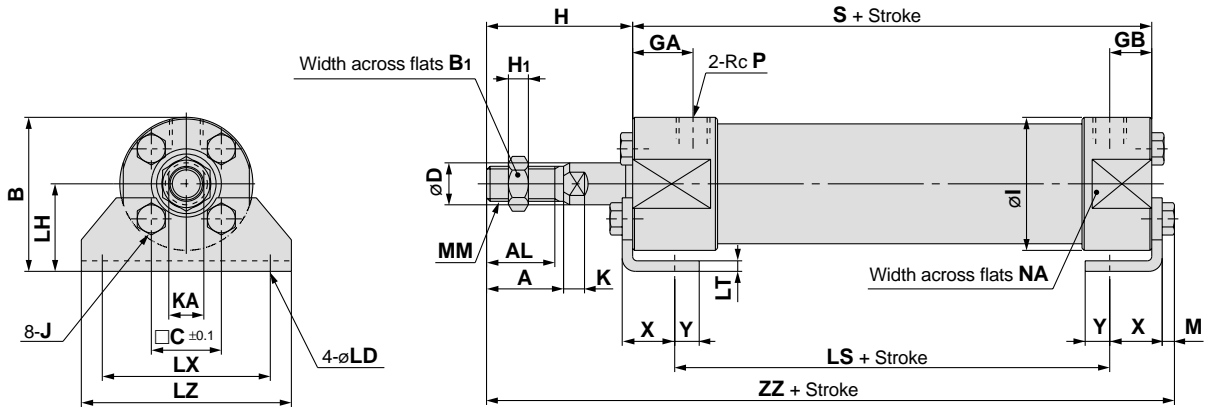

Bore size (mm)	Stroke range	A	AL	B ₁	B	C	D	GA	GB	H	H ₁	I	J	K	KA	LD	LH	LS	LT	LX	LZ	M	MM	NA	P	S	X	Y	ZZ
20	to 350	18	15.5	13	37.5	16.5	8	18	12	35	5	31	M4 x 0.7	5	6	6	22	59	3	40	50	3	M8 x 1.25	29	1/8	83	15	7	124
25	to 400	22	19.5	17	41.5	18.5	10	18	12	40	6	33	M5 x 0.8	5.5	8	6	25	59	3	44	60	3.5	M10 x 1.25	29	1/8	83	15	7	129.5
32	to 450	22	19.5	17	44	20	12	18	12	40	6	38	M5 x 0.8	5.5	10	7.2	25	59	3	44	60	3.5	M10 x 1.25	35.5	1/8	85	16	6	131.5
40	to 800	30	27	19	53.5	26	16	19	13	50	8	47	M6 x 1.0	6	14	7.2	30	66	3	54	75	4	M14 x 1.5	44	1/8	93	16.5	6.5	150
50	to 1200	35	32	27	69	32	20	21	14	58	11	58	M8 x 1.25	7	18	10	40	74	4	66	90	5.5	M18 x 1.5	55	1/4	109	21.5	11.5	176.5
63	to 1200	35	32	27	81	38	20	21	14	58	11	72	M10 x 1.5	7	18	12	45	74	4	82	110	7	M18 x 1.5	69	1/4	109	21.5	11.5	178
80	to 1400	40	37	32	99.5	50	25	28	20	71	13	89	M10 x 1.5	10	22	12	55	82	4	100	130	7	M22 x 1.5	80	3/8	130	28	17	212
100	to 1500	40	37	41	125	60	30	29	20	71	16	110	M12 x 1.75	10	26	14	70	83	6	120	160	8	M26 x 1.5	100	1/2	131	30	15	216

* Foot brackets and plug bolts are installed before shipment from factory.

Front flange type (F)/C□G5FN□S_V^R

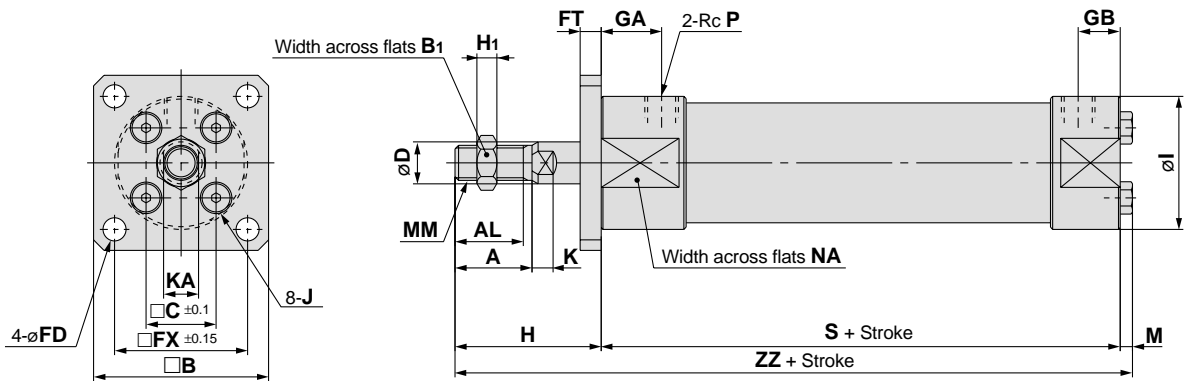

Bore size (mm)	Stroke range	A	AL	B ₁	B	C	D	FX	FD	FT	GA	GB	H	H ₁	I	J	K	KA	M	MM	NA	P	S	ZZ
20	to 350	18	15.5	13	50	16.5	8	36	5.5	6	18	12	35	5	31	M4 x 0.7	5	6	3	M8 x 1.25	29	1/8	83	121
25	to 400	22	19.5	17	50	18.5	10	36	5.5	6	18	12	40	6	33	M5 x 0.8	5.5	8	3.5	M10 x 1.25	29	1/8	83	126.5
32	to 450	22	19.5	17	50	20	12	38	6.6	6	18	12	40	6	38	M5 x 0.8	5.5	10	3.5	M10 x 1.25	35.5	1/8	85	128.5
40	to 800	30	27	19	60	26	16	46	6.6	6	19	13	50	8	47	M6 x 1.0	6	14	4	M14 x 1.5	44	1/8	93	147
50	to 1200	35	32	27	75	32	20	58	9	9	21	14	58	11	58	M8 x 1.25	7	18	5.5	M18 x 1.5	55	1/4	109	172.5
63	to 1200	35	32	27	90	38	20	70	11	9	21	14	58	11	72	M10 x 1.5	7	18	7	M18 x 1.5	69	1/4	109	174
80	to 1400	40	37	32	100	50	25	82	11	9	28	20	71	13	89	M10 x 1.5	10	22	7	M22 x 1.5	80	3/8	130	208
100	to 1500	40	37	41	125	60	30	100	14	10	29	20	71	16	110	M12 x 1.75	10	26	8	M26 x 1.5	100	1/2	131	210

* Flange brackets and plug bolts are installed before shipment from factory.

Dimensions

Rear flange type (G)/C□G5GN□S^R_V

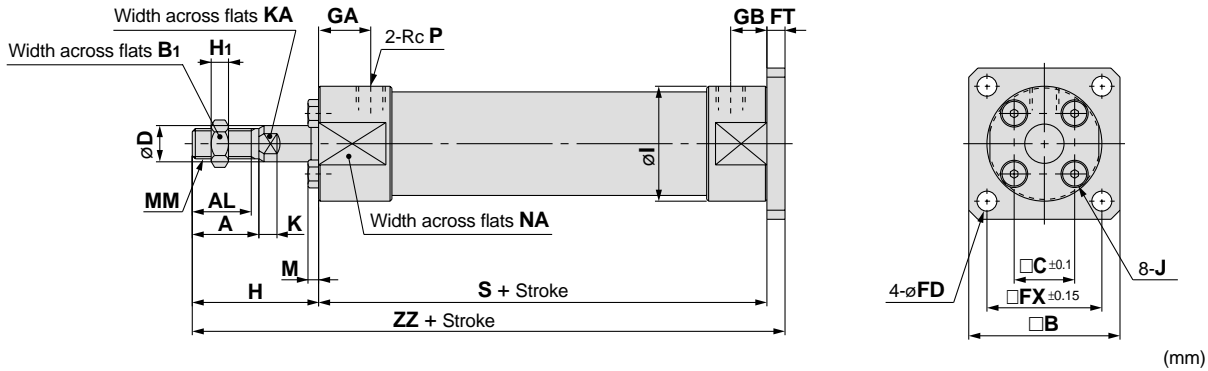

Bore size (mm)	Stroke range	A	AL	B1	B	C	D	FX	FD	FT	GA	GB	H	H1	I	J	K	KA	M	MM	NA	P	S	ZZ
20	to 200	18	15.5	13	50	16.5	8	36	5.5	6	18	12	35	5	31	M4 x 0.7	5	6	3	M8 x 1.25	29	1/8	83	124
25	to 300	22	19.5	17	50	18.5	10	36	5.5	6	18	12	40	6	33	M5 x 0.8	5.5	8	3.5	M10 x 1.25	29	1/8	83	129
32	to 300	22	19.5	17	50	20	12	38	6.6	6	18	12	40	6	38	M5 x 0.8	5.5	10	3.5	M10 x 1.25	35.5	1/8	85	131
40	to 500	30	27	19	60	26	16	46	6.6	6	19	13	50	8	47	M6 x 1.0	6	14	4	M14 x 1.5	44	1/8	93	149
50	to 600	35	32	27	75	32	20	58	9	9	21	14	58	11	58	M8 x 1.25	7	18	5.5	M18 x 1.5	55	1/4	109	176
63	to 600	35	32	27	90	38	20	70	11	9	21	14	58	11	72	M10 x 1.5	7	18	7	M18 x 1.5	69	1/4	109	176
80	to 750	40	37	32	100	50	25	82	11	9	28	20	71	13	89	M10 x 1.5	10	22	7	M22 x 1.5	80	3/8	130	210
100	to 750	40	37	41	125	60	30	100	14	10	29	20	71	16	110	M12 x 1.75	10	26	8	M26 x 1.5	100	1/2	131	212

* Flange brackets and plug bolts are installed before shipment from factory.

Integral clevis type (E)/C□G5EN□S^R_V

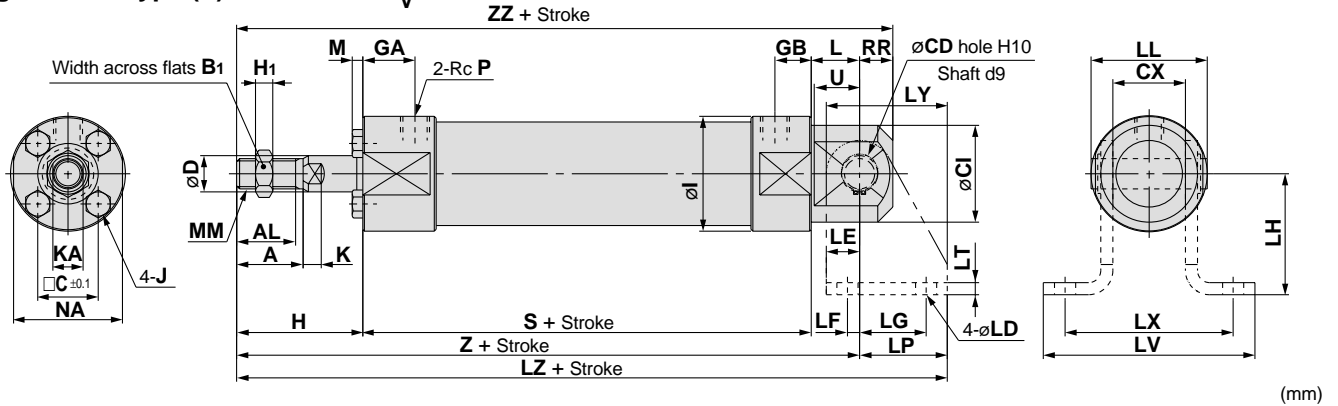

Bore size (mm)	Stroke range	A	AL	B1	C	CD (hole)	CI	CX	D	GA	GB	H	H1	I	J	K	KA	L	M	MM	NA	P	RR	S	U
20	to 200	18	15.5	13	16.5	8 ^{+0.058} ₀	25	16 ^{-0.2} _{-0.2}	8	18	12	35	5	31	M4 x 0.7	5	6	14	3	M8 x 1.25	29	1/8	9	83	13
25	to 300	22	19.5	17	18.5	8 ^{+0.058} ₀	27	16 ^{-0.2} _{-0.2}	10	18	12	40	6	33	M5 x 0.8	5.5	8	14	3.5	M10 x 1.25	29	1/8	9	83	13
32	to 300	22	19.5	17	20	10 ^{+0.058} ₀	32	24 ^{-0.2} _{-0.2}	12	18	12	40	6	38	M5 x 0.8	5.5	10	16	3.5	M10 x 1.25	35.5	1/8	11	85	15
40	to 500	30	27	19	26	10 ^{+0.058} ₀	40	24 ^{-0.2} _{-0.2}	16	19	13	50	8	47	M6 x 1.0	6	14	16	4	M14 x 1.5	44	1/8	11	93	15
50	to 600	35	32	27	32	14 ^{+0.070} ₀	50	40 ^{-0.2} _{-0.2}	20	21	14	58	11	58	M8 x 1.25	7	18	22	5.5	M18 x 1.5	55	1/4	15	109	21
63	to 600	35	32	27	38	14 ^{+0.070} ₀	60	40 ^{-0.2} _{-0.2}	20	21	14	58	11	72	M10 x 1.5	7	18	22	7	M18 x 1.5	69	1/4	15	109	21
80	to 750	40	37	32	50	22 ^{+0.084} ₀	75	60 ^{-0.3} _{-0.3}	25	28	20	71	13	89	M10 x 1.5	10	22	33	7	M22 x 1.5	80	3/8	23	130	32
100	to 750	40	37	41	60	22 ^{+0.084} ₀	90	60 ^{-0.3} _{-0.3}	30	29	20	71	16	110	M12 x 1.75	10	26	33	8	M26 x 1.5	100	1/2	23	131	32

Bore size (mm)	Z	ZZ	Trunnion bracket	CD (shaft)	LD	LE	LF	LG	LH	LL	LP	LT	LV	LX	LY	LZ
20	132	141	CG-E020SUS	8 ^{-0.040} _{-0.076}	7	9	2	14	30	27.6	21	3	56.5	42	30	153
25	137	146	CG-E020SUS	8 ^{-0.040} _{-0.076}	7	9	2	14	30	27.6	21	3	56.5	42	30	158
32	141	152	CG-E032SUS	10 ^{-0.040} _{-0.076}	7	11	4	22	40	38.4	29	4	70.5	56	40	170
40	159	170	CG-E032SUS	10 ^{-0.040} _{-0.076}	7	11	4	22	40	38.4	29	4	70.5	56	40	188
50	189	204	CG-E050SUS	14 ^{-0.050} _{-0.093}	12	15	5	25	50	59.6	35	6	106.5	84	50	224
63	189	204	CG-E050SUS	14 ^{-0.050} _{-0.093}	12	15	5	25	50	59.6	35	6	106.5	84	50	224
80	234	257	CG-E080SUS	22 ^{-0.065} _{-0.117}	14	23	6	40	80	87.2	57	9	144.5	120	80	291
100	235	258	CG-E080SUS	22 ^{-0.065} _{-0.117}	14	23	6	40	80	87.2	57	9	144.5	120	80	292

* Plug bolts are installed before shipment from factory.

* Trunnion brackets (with clevis pin and snap ring) are optional. (Not included.)

Series CG5-S

Accessory Dimensions

Single knuckle joint

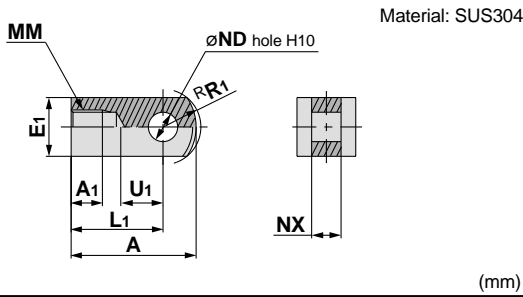

Part no.	Applicable bore size (mm)	A	A ₁	E ₁	L ₁	MM	ND _{H10}	NX	R ₁	U ₁
I-G02SUS	20	34	8.5	□16	25	M8 x 1.25	8 ^{+0.058} ₀	8 ^{-0.2} _{-0.4}	10.3	11.5
I-G03SUS	25, 32	41	10.5	□20	30	M10 x 1.25	10 ^{+0.058} ₀	10 ^{-0.2} _{-0.4}	12.8	14
I-G04SUS	40	42	14	□22	30	M14 x 1.5	10 ^{+0.058} ₀	18 ^{-0.3} _{-0.5}	12	14
I-G05SUS	50, 63	56	18	□28	40	M18 x 1.5	14 ^{+0.070} ₀	22 ^{-0.3} _{-0.5}	16	20
I-G08SUS	80	71	21	□38	50	M22 x 1.5	18 ^{+0.070} ₀	28 ^{-0.3} _{-0.5}	21	27
I-G10SUS	100	79	21	□45	55	M26 x 1.5	22 ^{+0.084} ₀	32 ^{-0.3} _{-0.5}	24	31

Double knuckle joint

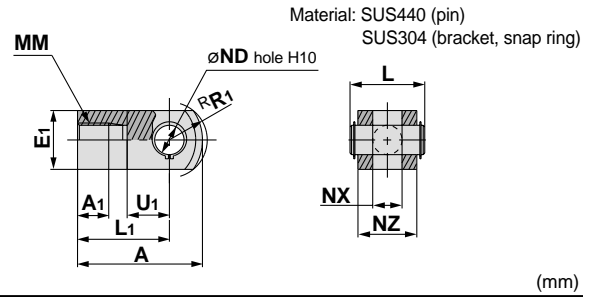

Part no.	Applicable bore size (mm)	A	A ₁	E ₁	L	L ₁	MM	ND _{H10}	NX	NZ	R ₁	U ₁	Applicable pin no.
Y-G02SUS	20	34	8.5	16	21	25	M8 x 1.25	8 ^{+0.058} ₀	8 ^{+0.4} _{+0.2}	16	10.3	11.5	IY-G02SUS
Y-G03SUS	25,32	41	10.5	20	25.6	30	M10 x 1.25	10 ^{+0.058} ₀	10 ^{+0.4} _{+0.2}	20	12.8	14	IY-G03SUS
Y-G04SUS	40	42	16	22	41.6	30	M14 x 1.5	10 ^{+0.058} ₀	18 ^{+0.5} _{+0.3}	36	12	14	IY-G04SUS
Y-G05SUS	50,63	56	20	25	50.6	40	M18 x 1.5	14 ^{+0.070} ₀	22 ^{+0.5} _{+0.3}	44	16	20	IY-G05SUS
Y-G08SUS	80	71	23	35	64	50	M22 x 1.5	18 ^{+0.070} ₀	28 ^{+0.5} _{+0.3}	56	21	27	IY-G08SUS
Y-G10SUS	100	79	24	40	72	55	M26 x 1.5	22 ^{+0.084} ₀	32 ^{+0.5} _{+0.3}	64	24	31	IY-G10SUS

Knuckle joint pin

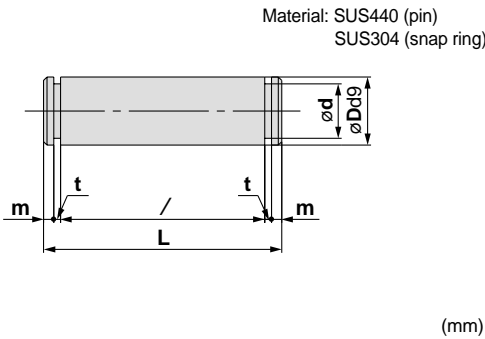

Part no.	Applicable bore size (mm)	Dd ₉	d	L	/	m	t	Snap ring
IY-G02SUS	20	8 ^{-0.040} _{-0.076}	7.6	21	16.2	1.5	0.9	C type 8 for shaft
IY-G03SUS	25, 32	10 ^{-0.040} _{-0.076}	9.6	25.6	20.2	1.55	1.15	C type 10 for shaft
IY-G04SUS	40	10 ^{-0.040} _{-0.076}	9.6	41.6	36.2	1.55	1.15	C type 10 for shaft
IY-G05SUS	50, 63	14 ^{-0.050} _{-0.093}	13.4	50.6	44.2	2.05	1.15	C type 14 for shaft
IY-G08SUS	80	18 ^{-0.050} _{-0.093}	17	64	56.2	2.55	1.35	C type 18 for shaft
IY-G10SUS	100	22 ^{-0.065} _{-0.117}	21	72	64.2	2.55	1.35	C type 22 for shaft

Trunnion bracket

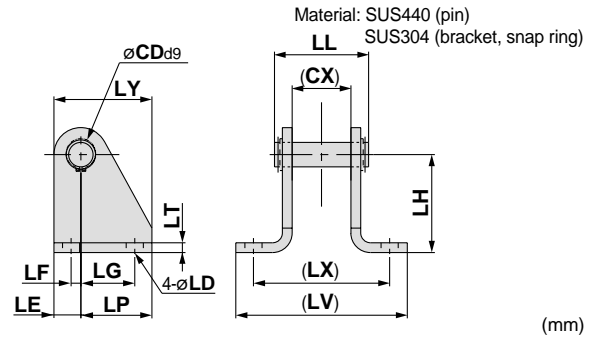

Part no.	Applicable bore size (mm)	CD (snap ring)	CX	LD	LE	LF	LG	LH	LL	LP	LT	LV	LX	LY
CG-E020SUS	20, 25	8 ^{-0.040} _{-0.076}	16	7	9	2	14	30	27.6	21	3	56.5	42	30
CG-E032SUS	32, 40	10 ^{-0.040} _{-0.076}	24	7	11	4	22	40	38.4	29	4	70.5	56	40
CG-E050SUS	50, 63	14 ^{-0.050} _{-0.093}	40	12	15	5	25	50	59.6	35	6	106.5	84	50
CG-E080SUS	80, 100	22 ^{-0.065} _{-0.117}	60	14	23	6	40	80	87.2	57	9	144.5	120	80

Clevis pin

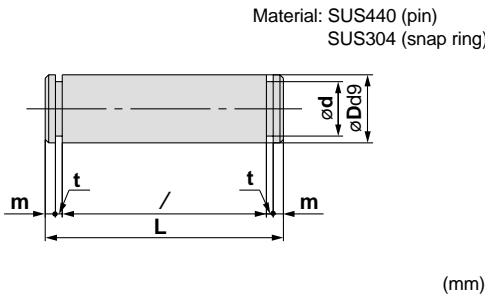

Part no.	Applicable bore size (mm)	Dd ₉	d	L	/	m	t	Snap ring
CD-E02SUS	20, 25	ø8 ^{-0.040} _{-0.076}	7.6	27.6	22.8	1.5	0.9	C type 8 for shaft
CD-E03SUS	32, 40	ø10 ^{-0.040} _{-0.076}	9.6	38.4	33	1.55	1.15	C type 10 for shaft
CD-E05SUS	50, 63	ø14 ^{-0.050} _{-0.093}	13.4	59.6	53.2	2.05	1.15	C type 14 for shaft
CD-E08SUS	80, 100	ø22 ^{-0.065} _{-0.117}	21	87.2	79.4	2.55	1.35	C type 22 for shaft

Rod end nut

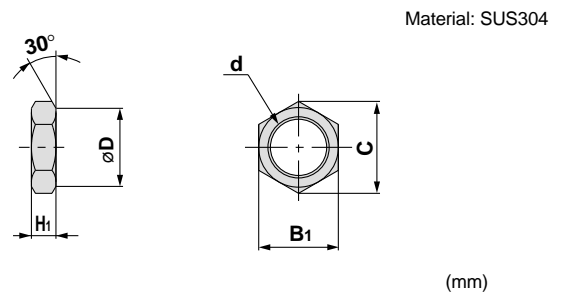

Part no.	Applicable bore size (mm)	B ₁	C	D	d	H ₁
NT-02SUS	20	13	(15)	12.5	M8 x 1.25	5
NT-03SUS	25, 32	17	(19.6)	16.5	M10 x 1.25	6
NT-G04SUS	40	19	(21.9)	18	M14 x 1.5	8
NT-05SUS	50, 63	27	(31.2)	26	M18 x 1.5	11
NT-08SUS	80	32	(37.0)	31	M22 x 1.5	13
NT-10SUS	100	41	(47.3)	39	M26 x 1.5	16

Series CJ5-S/CG5-S Auto Switch Specifications

Auto Switch Common Specifications

Type	Solid State Switch
Operating time	1ms or less
Impact resistance	1000m/s ²
Insulation resistance	50MΩ or more at 500VDC (between lead wire and case)
Withstand voltage	1000VAC for 1 min. (between lead wire and case)
Ambient temperature	-10 to 60°C
Enclosure	IEC529 standard IP67, JISC0920 watertight construction

Lead Wire Length

The standard lead wire length for water resistant 2 color indication solid state auto switches is 3 meters. (0.5m is not available.)

For solid state switches with flexible specification, enter "-61" after the lead wire length.

(Example) D-H7BAL- 61

● Flexible specification

Lead Wire Color Changes

2 wire

	Old	New
Output (+)	Red	Brown
Output (-)	Black	Blue

Lead wire colors of SMC switches have been changed as shown below in order to meet NECA Standard 0402 for production beginning September, 1996 and thereafter.

Special care should be taken regarding wire polarity during the time that the old colors still coexist with the new colors.

Auto Switch Mounting Positions and Minimum Mountable Strokes

D-H7BAL

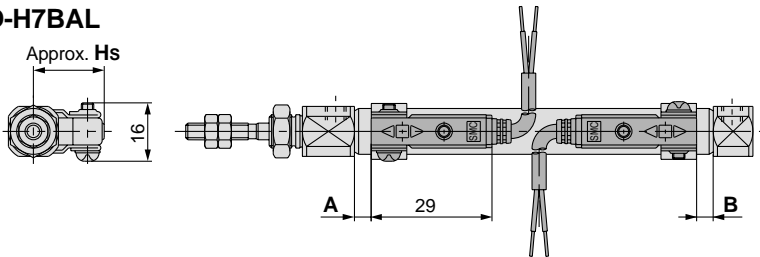

Minimum strokes for auto switch mounting

Mounting bracket	Basic type, Foot type, Flange type, Clevis type		
Number of switches	1 pc. (Rod cover side)	2 pcs. (Different sides)	2 pcs. (Same side)
Mounting surface	Port surface 	Port surface 	Port surface
Switch type			
Minimum stroke (mm)	10	15	60

Auto switch mounting positions (mm)

Applicable bore size (mm)	Auto switch model	D-H7BAL		
		A	B	HS
10		0	0	17
16		0.5	0.5	20.5

D-G5BAL

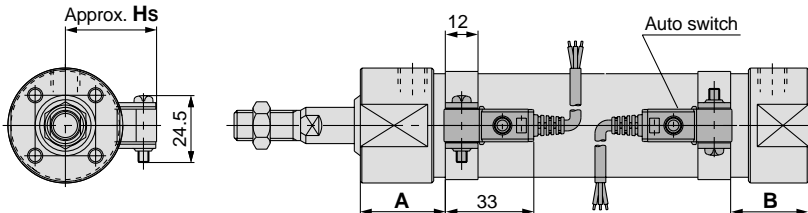

Minimum strokes for auto switch mounting

Mounting bracket	Basic type, Foot type, Flange type, Clevis type		
Number of switches	1 pc. (Rod cover side)	2 pcs. (Different sides)	2 pcs. (Same side)
Mounting surface	Port surface 	Port surface 	Port surface
Switch type			
Minimum stroke (mm)	10	15	75

Auto switch mounting position (mm)

Applicable bore size (mm)	Auto switch model	D-G5BAL		
		A	B	HS
20		31.5	24	26
25		31.5	24	28.5
32		32.5	25	33
40		37	28	36.5
50		45.5	36	42
63		45.5	36	48.5
80		56	46	57.5
100		57	46	68

Water Resistant 2 Color Indication Solid State Switch Band Mount Type D-H7BAL

Grommet

Water (coolant) resistant type



Caution

Operating Precaution

Consult SMC if a solution other than water is to be used.

Auto switch specifications

D-H7BAL (with indicator light)	
Auto switch part no.	D-H7BAL
Wiring type	2 wire
Output type	—
Applicable load	24VDC relay, PLC
Power supply voltage	—
Current consumption	—
Load voltage	24VDC (10 to 28VDC)
Load current	5 to 40mA
Internal voltage drop	4V or less
Leakage current	0.8mA or less at 24VDC
Indicator light	Actuated position Red LED lights up Optimum operating position ... Green LED lights up

• Lead wire — Oil resistant heavy duty vinyl cord, $\phi 3, 4, 0.2\text{mm}^2$, 2 cores (brown, blue [red, black]), 3m (standard)
Note 1) Refer to page 15 for auto switch common specifications.
Note 2) Refer to page 15 for lead wire length.

Most Sensitive Position

Auto Switch Internal Circuits

Lead wire colors inside [] are those prior to conformity with IEC standards.

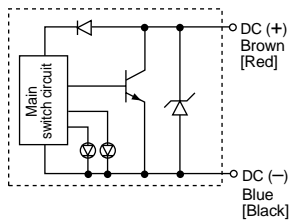

Indicator light/Display method

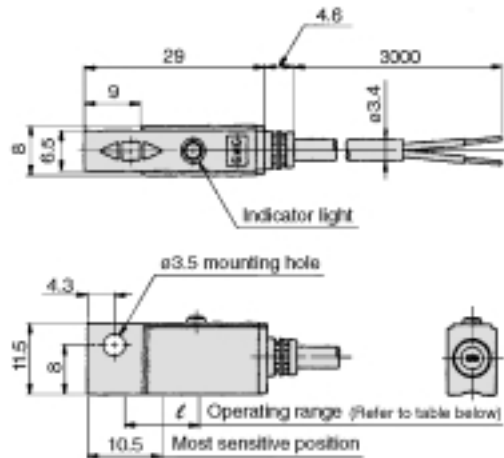
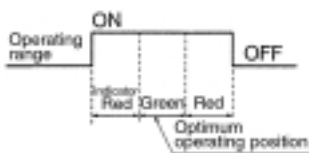

	(mm)	
Bore size (mm)	10	16
Operating range (°)	5	5

Water Resistant 2 Color Indication Solid State Switch Band Mount Type D-G5BAL

Grommet

Water (coolant) resistant type



Caution

Operating Precaution

Consult SMC if a solution other than water is to be used.

Auto Switch Internal Circuits

Lead wire colors inside [] are those prior to conformity with IEC standards.

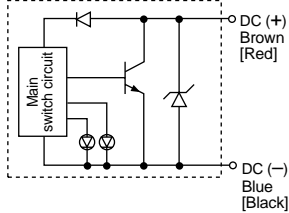

Indicator light/Display method



Auto switch specifications

D-G5BAL (with indicator light)	
Auto switch part no.	D-G5BAL
Wiring type	2 wire
Output type	—
Applicable load	24VDC relay, PLC
Power supply voltage	—
Current consumption	—
Load voltage	24VDC (10 to 28VDC)
Load current	5 to 40mA
Internal voltage drop	4V or less
Leakage current	0.8mA or less at 24VDC
Indicator light	Actuated position Red LED lights up Optimum operating position ... Green LED lights up

* Lead wire — Oil resistant heavy duty vinyl cord, $\phi 4$, 0.3mm², 2 cores (brown, blue [red, black]), 3m (standard)
Note 1) Refer to page 15 for auto switch common specifications.
Note 2) Refer to page 15 for lead wire length.

Most Sensitive Position

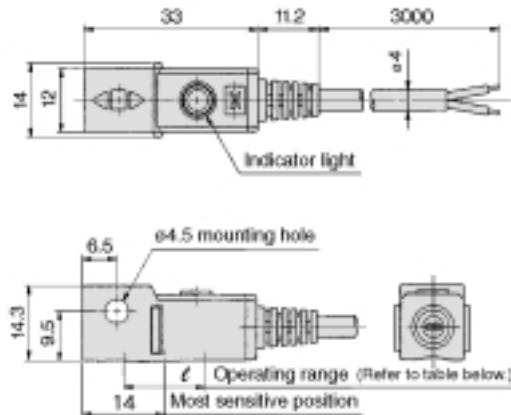

Bore size (mm)	20	25	32	40	50	63	80	100
Operating range (°)	5	5	5.5	6	7	7.5	7.5	8

Related Equipment

Water Resistant Air Cylinder

- For use in environments with water spray such as food processing machines and car wash machines
- Special scraper

• Dramatically improved water resistance compared to standard cylinders

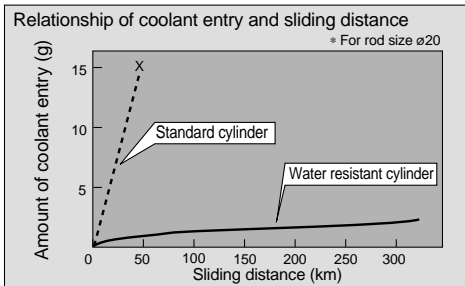

Conditions

Working fluid Air
Pressure 0.5MPa
Coolant Water-soluble
Piston speed 200mm/sec (60cpm)

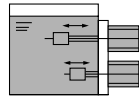

- Two types of standard seal material
- Nitrile rubber (NBR)
- Fluoro rubber (FKM)

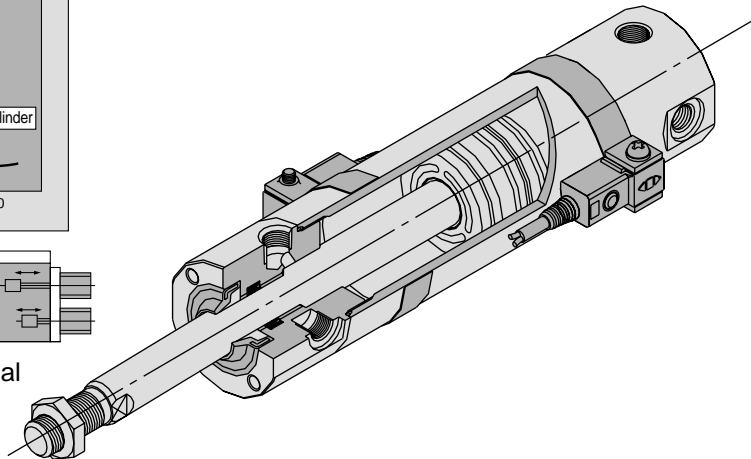

Series CM2 $\phi 20$ to $\phi 40$



Specifications

Action	Double acting single rod
Bore size (mm)	$\phi 20, \phi 25, \phi 32, \phi 40$
Cushion	Rubber bumper
Switch mounting type	Band mount type
Made to order	Piston rod/Rod end nut material: Stainless steel (-XC6)

* Specifications other than above are identical to the standard basic type.

Series CG1 $\phi 32$ to $\phi 100$



Specifications

Action	Double acting single rod
Bore size (mm)	$\phi 32, \phi 40, \phi 50, \phi 63, \phi 80, \phi 100$
Cushion	Rubber bumper, Air cushion
Switch mounting type	Band mount type
Made to order	Piston rod/Rod end nut material: Stainless steel (-XC6)

* Specifications other than above are identical to the standard basic type.

How to Order

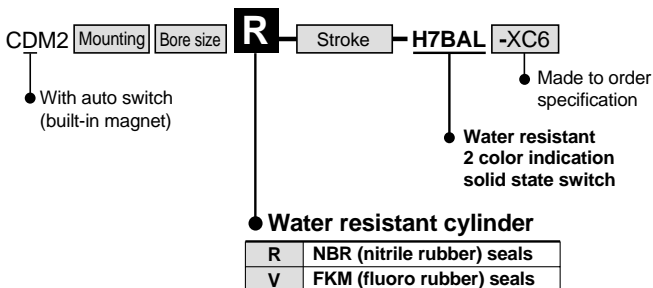

How to Order

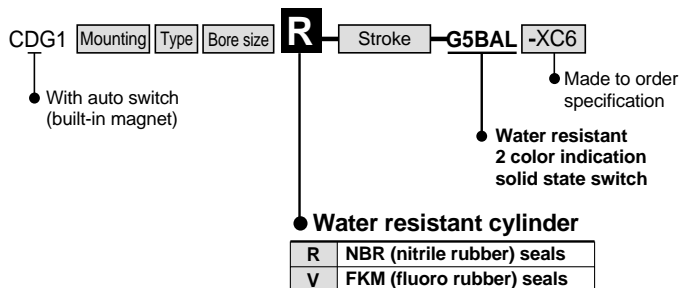

Related Equipment

Water Resistant Air Cylinder

Compact cylinder

Series **CQ2** $\varnothing 20$ to $\varnothing 100$



Specifications

Action	Double acting single rod
Bore size (mm)	$\varnothing 20$, $\varnothing 25$, $\varnothing 32$, $\varnothing 40$, $\varnothing 50$, $\varnothing 63$, $\varnothing 80$, $\varnothing 100$
Cushion	None
Switch mounting type	Rail mount type
Made to order	Piston rod/Rod end nut material: Stainless steel (-XC6)

* Specifications other than above are identical to the standard basic type.

How to Order

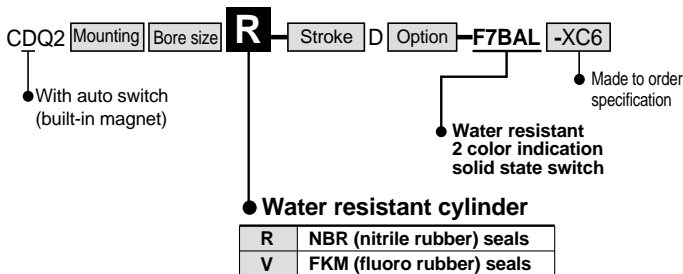

Series **CA1** $\varnothing 40$ to $\varnothing 100$



Specifications

Action	Double acting single rod
Bore size (mm)	$\varnothing 40$, $\varnothing 50$, $\varnothing 63$, $\varnothing 80$, $\varnothing 100$
Cushion	Air cushion
Switch mounting type	Tie-rod mount type
Made to order	Piston rod/Rod end nut material: Stainless steel (-XC6)

* Specifications other than above are identical to the standard basic type.

Note 1) Air-hydro type and boot specification of series CA1 are excluded.

Note 2) Combination of auto switches and steel tube is not available.

How to Order

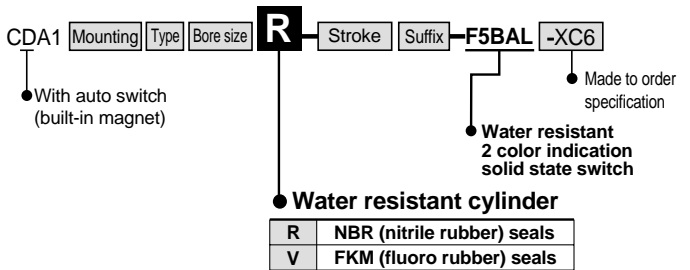

Compact guide cylinder

Series **MGP** $\varnothing 20$ to $\varnothing 100$



Specifications

Action	Double acting
Bore size (mm)	$\varnothing 20$, $\varnothing 25$, $\varnothing 32$, $\varnothing 40$, $\varnothing 50$, $\varnothing 63$, $\varnothing 80$, $\varnothing 100$
Bearing type	Slide bearing
Cushion	Rubber bumper
Switch mounting type	Direct mount type

* Specifications other than above are identical to the standard basic type.

How to Order

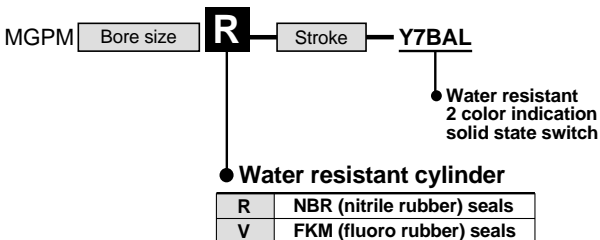

* Use of stainless steel as the piston rod material will be treated as a special order.

Cylinder with guide

Series **MGG** $\varnothing 32$ to $\varnothing 50$

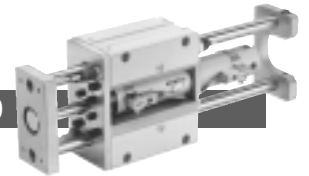

Specifications

Action	Double acting
Bore size (mm)	$\varnothing 32$, $\varnothing 40$, $\varnothing 50$
Bearing type	Slide bearing
Cushion	Rubber bumper, Built-in shock absorber
Switch mounting type	Band mount type

* Specifications other than above are identical to the standard basic type.

Note 1) RBL (coolant resistant) type shock absorber is used.

How to Order

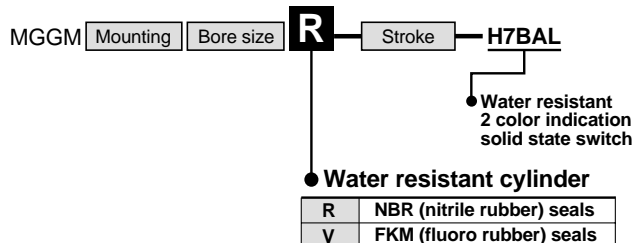

* Use of stainless steel as the piston rod material will be treated as a special order.

Related Equipment Speed Controller with One-touch Fittings Stainless Steel Series



Refer to "Best Pneumatics No. 3" for details.

Elbow Type/Universal Type

AS-FG

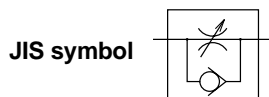

Applicable tubing O.D. (mm)	Connection threads	Model			
		Elbow type		Universal type	
		Meter-out	Meter-in	Meter-out	Meter-in
3.2	M5 x 0.8	AS1201FG-M5-23	AS1211FG-M5-23	AS1301FG-M5-23	AS1311FG-M5-23
	R 1/8	AS2201FG-01-23	AS2211FG-01-23	AS2301FG-01-23	AS2311FG-01-23
4	M5 x 0.8	AS1201FG-M5-04	AS1211FG-M5-04	AS1301FG-M5-04	AS1311FG-M5-04
	R 1/8	AS2201FG-01-04	AS2211FG-01-04	AS2301FG-01-04	AS2311FG-01-04
	R 1/4	-02-04	-02-04	-02-04	-02-04
6	M5 x 0.8	AS1201FG-M5-06	AS1211FG-M5-06	AS1301FG-M5-06	AS1311FG-M5-06
	R 1/8	AS2201FG-01-06	AS2211FG-01-06	AS2301FG-01-06	AS2311FG-01-06
	R 1/4	-02-06	-02-06	-02-06	-02-06
		AS3201FG-02-06	AS3211FG-02-06	AS3301FG-02-06	AS3311FG-02-06
	R 3/8	-03-06	-03-06	-03-06	-03-06
8	R 1/8	AS2201FG-01-08	AS2211FG-01-08	AS2301FG-01-08	AS2311FG-01-08
	R 1/4	-02-08	-02-08	-02-08	-02-08
		AS3201FG-02-08	AS3211FG-02-08	AS3301FG-02-08	AS3311FG-02-08
	R 3/8	-03-08	-03-08	-03-08	-03-08
10	R 1/8	AS2201FG-01-10	AS2211FG-01-10	—	—
	R 1/4	-02-10	-02-10	AS2301FG-02-10	AS2311FG-02-10
		AS3201FG-02-10	AS3211FG-02-10	AS3301FG-02-10	AS3311FG-02-10
	R 3/8	-03-10	-03-10	-03-10	-03-10
	R 1/2	AS4201FG-04-10	AS4211FG-04-10	AS4301FG-04-10	AS4311FG-04-10
12	R 1/4	AS3201FG-02-12	AS3211FG-02-12	AS3301FG-02-12	AS3311FG-02-12
	R 3/8	-03-12	-03-12	-03-12	-03-12
	R 1/2	AS4201FG-04-12	AS4211FG-04-12	AS4301FG-04-12	AS4311FG-04-12

In-line Type

AS-FG

SUS303

JIS symbol

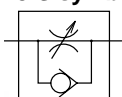

Applicable tubing O.D. (mm)	Model	
	In-line type	
3.2	AS1001FG-23	
4	AS1001FG-04	
	AS2001FG-04	
6	AS1001FG-06	
	AS2001FG-06	
	AS2051FG-06	
	AS3001FG-06	

Applicable tubing O.D. (mm)	Model	
	In-line type	
8	AS2051FG-08	
	AS3001FG-08	
10	AS3001FG-10	
	AS4001FG-10	
12	AS3001FG-12	
	AS4001FG-12	

Refer to "Best Pneumatics No. 3" for inch sizes.

Dual Speed Controller

ASD-FG

SUS303

Provides lurching prevention and controls speed of single acting cylinders.

JIS symbol

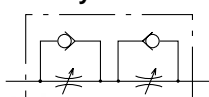

Applicable tubing O.D. (mm)	Connection threads	Model	
		Universal type	
4	M5 x 0.8	ASD230FG-M5-04	
	M5 x 0.8	ASD230FG-M5-06	
6	R 1/8	ASD330FG-01-06S	
	R 1/4	ASD430FG-02-06S	
		ASD530FG-02-06S	
	R 3/8	-03-06S	
8	R 1/8	ASD330FG-01-08S	
	R 1/4	ASD430FG-02-08S	
		ASD530FG-02-08S	
R 3/8	-03-08S		

Applicable tubing O.D. (mm)	Connection threads	Model	
		Universal type	
10	R 1/4	ASD430FG-02-10S	
	R 3/8	ASD530FG-02-10S	
		-03-10S	
12	R 1/2	ASD630FG-04-10S	
	R 1/4	ASD530FG-02-12S	
12	R 3/8	-03-12S	
	R 1/2	ASD630FG-04-12S	

Refer to "Best Pneumatics No. 3" for inch sizes.

Related Equipment



Refer to "Best Pneumatics No. 4" for details.

One-touch Fittings/Stainless Steel Series

Male Connector KGH

Applicable tubing O.D. (mm)	Connection threads	Model
4	M5 x 0.8	KGH04-M5
	R 1/8	-01
	R 1/4	-02
6	M5 x 0.8	KGH06-M5
	R 1/8	-01
	R 1/4	-02
	R 3/8	-03
8	R 1/8	KGH08-01
	R 1/4	-02
	R 3/8	-03
10	R 1/8	KGH10-01
	R 1/4	-02
	R 3/8	-03
12	R 1/2	-04
	R 1/4	KGH12-02
	R 3/8	-03
16	R 1/2	-04
	R 3/8	KGH16-03
	R 1/2	-04



<M5 type>



<R type>

Male Elbow KGL

Applicable tubing O.D. (mm)	Connection threads	Model
4	M5 x 0.8	KGL04-M5
	R 1/8	-01
	R 1/4	-02
6	M5 x 0.8	KGL06-M5
	R 1/8	-01
	R 1/4	-02
	R 3/8	-03
8	R 1/8	KGL08-01
	R 1/4	-02
	R 3/8	-03
10	R 1/8	KGL10-01
	R 1/4	-02
	R 3/8	-03
	R 1/2	-04
12	R 1/4	KGL12-02
	R 3/8	-03
	R 1/2	-04
16	R 3/8	KGL16-03
	R 1/2	-04



<M5 type>



<R type>

Hexagon Socket Head Male Connector KGS

Applicable tubing O.D. (mm)	Connection threads	Model
4	M5 x 0.8	KGS04-M5
	R 1/8	-01
6	M5 x 0.8	KGS06-M5
	R 1/8	-01
	R 1/4	-02
8	R 1/8	KGS08-01
	R 1/4	-02
	R 3/8	-03
10	R 1/8	KGS10-01
	R 1/4	-02
	R 3/8	-03
	R 1/2	-04
12	R 1/4	KGS12-02
	R 3/8	-03
	R 1/2	-04



<M5 type>



<R type>

Extended Male Elbow KGW

Applicable tubing O.D. (mm)	Connection threads	Model
4	M5 x 0.8	KGW04-M5
	R 1/8	-01
	R 1/4	-02
6	M5 x 0.8	KGW06-M5
	R 1/8	-01
	R 1/4	-02
	R 3/8	-03
8	R 1/8	KGW08-01
	R 1/4	-02
	R 3/8	-03
10	R 1/4	KGW10-02
	R 3/8	-03
	R 1/2	-04
12	R 1/4	KGW12-02
	R 3/8	-03
	R 1/2	-04



<M5 type>



<R type>

Male Run Tee KGY

Applicable tubing O.D. (mm)	Connection threads	Model
4	M5 x 0.8	KGY04-M5
	R 1/8	-01
	R 1/4	-02
6	M5 x 0.8	KGY06-M5
	R 1/8	-01
	R 1/4	-02
	R 3/8	-03
8	R 1/8	KGY08-01
	R 1/4	-02
	R 3/8	-03
10	R 1/8	KGY10-01
	R 1/4	-02
	R 3/8	-03
	R 1/2	-04
12	R 1/4	KGY12-02
	R 3/8	-03
	R 1/2	-04
16	R 3/8	KGY16-03
	R 1/2	-04



<M5 type>



<R type>

Universal Male Elbow KGV

Applicable tubing O.D. (mm)	Connection threads	Model
4	M5 x 0.8	KGV04-M5
	R 1/8	-01
6	M5 x 0.8	KGV06-M5
	R 1/8	-01
	R 1/4	-02
8	R 1/8	KGV08-01
	R 1/4	-02
	R 3/8	-03
10	R 1/4	KGV10-02
	R 3/8	-03
12	R 3/8	KGV12-03
	R 1/2	-04







<M5 type>





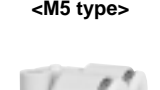

<R type>

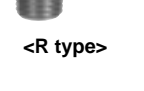

Branch Tee KGT

	Applicable tubing O.D. (mm)	Connection threads	Model
 <M5 type>	4	M5 x 0.8	KGT04-M5
		R 1/8	-01
		R 1/4	-02
 <6 type>	6	M5 x 0.8	KGT06-M5
		R 1/8	-01
		R 1/4	-02
		R 3/8	-03
 <8 type>	8	R 1/8	KGT08-01
		R 1/4	-02
		R 3/8	-03
 <10 type>	10	R 1/8	KGT10-01
		R 1/4	-02
		R 3/8	-03
		R 1/2	-04
 <12 type>	12	R 1/4	KGT12-02
		R 3/8	-03
		R 1/2	-04
 <16 type>	16	R 3/8	KGT16-03
		R 1/2	-04





Branch Male Elbow KGLU

	Applicable tubing O.D. (mm)	Connection threads	Model
 <M5 type>	4	M5 x 0.8	KGLU04-M5
		R 1/8	-01
		R 1/4	-02
 <6 type>	6	M5 x 0.8	KGLU06-M5
		R 1/8	-01
		R 1/4	-02
		R 3/8	-03
 <8 type>	8	R 1/8	KGLU08-01
		R 1/4	-02
		R 3/8	-03
 <10 type>	10	R 1/4	KGLU10-02
		R 3/8	-03
		R 1/2	-04
		R 1/4	KGLU12-02
 <12 type>	12	R 3/8	-03
		R 1/2	-04



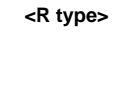

Double Branch "Y" KGUD

	Applicable tubing O.D. (mm)	Connection threads	Model
 <4 type>	4	R 1/8	KGUD04-01
		R 1/4	-02
 <6 type>	6	R 1/8	KGUD06-01
		R 1/4	-02

Plug-in "Y" KGU

	Applicable tubing O.D. (mm)	Connection threads	Model
 <M5 type>	4	M5 x 0.8	KGU04-M5
		R 1/8	-01
		R 1/4	-02
 <6 type>	6	M5 x 0.8	KGU06-M5
		R 1/8	-01
		R 1/4	-02
		R 3/8	-03
 <8 type>	8	R 1/8	KGU08-01
		R 1/4	-02
		R 3/8	-03
 <10 type>	10	R 1/4	KGU10-02
		R 3/8	-03
		R 1/2	-04
		R 1/4	KGU12-02
 <12 type>	12	R 3/8	-03
		R 1/2	-04

Male Delta KGD

	Applicable tubing O.D. (mm)	Connection threads	Model
 <M5 type>	4	M5 x 0.8	KGD04-M5
		R 1/8	-01
		R 1/4	-02
 <6 type>	6	M5 x 0.8	KGD06-M5
		R 1/8	-01
		R 1/4	-02
		R 3/8	-03
 <8 type>	8	R 1/8	KGD08-01
		R 1/4	-02
		R 3/8	-03
 <10 type>	10	R 1/4	KGD10-02
		R 3/8	-03
		R 1/2	-04
		R 1/4	KGD12-02
 <12 type>	12	R 3/8	-03
		R 1/2	-04

Straight Union KGH

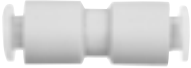
	Applicable tubing O.D. (mm)	Model
	4	KGH04-00
	6	KGH06-00
	8	KGH08-00
	10	KGH10-00
	12	KGH12-00

Bulkhead Union KGE

	Applicable tubing O.D. (mm)	Model
	4	KGE04-00
	6	KGE06-00
	8	KGE08-00
	10	KGE10-00
	12	KGE12-00
	16	KGE16-00

Related Equipment One-touch Fittings/Stainless Steel Series



Refer to "Best Pneumatics No. 4" for details.

Union Elbow KGL

Applicable tubing O.D. (mm)	Model
6	KGL06-00
8	KGL08-00
10	KGL10-00
12	KGL12-00
16	KGL16-00



Different Dia. Tee KGT

Applicable tubing O.D. (mm)	Model
4	KGT04-06
6	KGT06-08
8	KGT08-10
10	KGT10-12

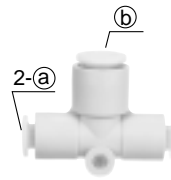

Union Tee KGT

Applicable tubing O.D. (mm)	Model
6	KGT06-00
8	KGT08-00
10	KGT10-00
12	KGT12-00
16	KGT16-00



Different Dia. Union "Y" KGU

Applicable tubing O.D. (mm)	Model
4	KGU04-06
6	KGU06-08
8	KGU08-10
10	KGU10-12



Union "Y" KGU

Applicable tubing O.D. (mm)	Model
6	KGU06-00
8	KGU08-00
10	KGU10-00
12	KGU12-00



Different Dia. Double Union "Y" KGUD

Applicable tubing O.D. (mm)	Model
4	KGUD04-06
6	KGUD06-08



Different Dia. Straight KGH

Applicable tubing O.D. (mm)	Model
4	KGH04-06
6	KGH06-08
8	KGH08-10
10	KGH10-12

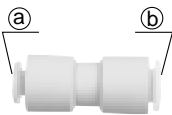

Branch Elbow KGLU

Applicable tubing O.D. (mm)	Model
6	KGLU06-00
8	KGLU08-00
10	KGLU10-00
12	KGLU12-00



Delta KGD

Applicable tubing O.D. (mm)	Model
6	KGD06-00
8	KGD08-00
10	KGD10-00
12	KGD12-00



Female Union KGF

Applicable tubing O.D. (mm)	Connection threads	Model
	Rc 1/4	-02
6	Rc 1/8	KGF06-01
	Rc 1/4	-02
	Rc 3/8	-03
8	Rc 1/8	KGF08-01
	Rc 1/4	-02
	Rc 3/8	-03
10	Rc 1/4	KGF10-02
	Rc 3/8	-03
12	Rc 1/4	KGF12-02
	Rc 3/8	-03
	Rc 1/2	-04



Plug-in Elbow KGL

	Applicable tubing O.D. (mm)	Applicable fitting size	Model
	4	4	4
6	6	6	KGL06-99
8	8	8	KGL08-99
10	10	10	KGL10-99
12	12	12	KGL12-99

Plug-in Reducer KGR

	Applicable tubing O.D. (mm)	Applicable fitting size	Model
	4	6	6
8		8	-08
10		10	-10
6	4	4	KGR06-04
	8	8	-08
	10	10	-10
	12	12	-12
8	10	10	KGR08-10
	12	12	-12
10	12	12	KGR10-12
	16	16	-16
12	16	16	KGR12-16

Bulkhead Connector KGE

	Applicable tubing O.D. (mm)	Connection threads	Model
	4	R 1/8	R 1/8
R 1/4		R 1/4	-02
6	R 1/8	R 1/8	KGE06-01
	R 1/4	R 1/4	-02
	R 3/8	R 3/8	-03
8	R 1/8	R 1/8	KGE08-01
	R 1/4	R 1/4	-02
	R 3/8	R 3/8	-03
10	R 1/4	R 1/4	KGE10-02
	R 3/8	R 3/8	-03
12	R 3/8	R 3/8	KGE12-03
	R 1/2	R 1/2	-04
	R 3/8	R 3/8	KGE16-03
16	R 1/2	R 1/2	-04

Tube Cap KGC

	Applicable tubing O.D. (mm)	Model
	4	4
6	6	KGC06-00
8	8	KGC08-00
10	10	KGC10-00
12	12	KGC12-00
16	16	KGC16-00

Related Equipment Miniature Fittings



Refer to "Best Pneumatics No. 4" for details.

Series MS

Description	Note	Model	Application
Barb fitting for soft tube 	ø3.18/2.18 x M5	MS-5AU-3	For piping soft nylon tubing
	ø3.18/2 x M5		For piping polyurethane tubing
	ø4/2.5 x M5	MS-5AU-4	For piping soft nylon and polyurethane tubing
ø6/4 x M5	MS-5AU-6		
Barb elbow for soft tube 	ø3.18/2.18 x M5	MS-5ALHU-3	For piping soft nylon tubing
	ø3.18/2 x M5		For piping polyurethane tubing
	ø4/2.5 x M5	MS-5ALHU-4	Unrestricted 360° positioning and fastening around the stud axis
ø6/4 x M5	MS-5ALHU-6		
Hose nipple 	ø4/2.5 x M5	MS-5H-4	For piping nylon, soft nylon and polyurethane tubing
	ø6/4 x M5	MS-5H-6	
Hose elbow 	ø4/2.5 x M5	MS-5HLH-4	• For piping nylon, soft nylon and polyurethane tubing
	ø6/4 x M5	MS-5HLH-6	• Unrestricted 360° positioning and fastening around the stud axis
Gasket 	Material: PVC	M-5G1	Seal for M5 threads

Description	Note	Model	Application
Universal elbow 	M5 female x M5 male	MS-5UL	Unrestricted 360° positioning and fastening around the stud axis
Universal tee 	M5 female x M5 female x M5 male	MS-5UT	Unrestricted 360° positioning and fastening around the stud axis
Reducer bushing 	R 1/8 x M5 female	MS-5B	Connects Rc 1/8 to M5 fitting
Plug 		MS-5P	Closes the unused M5 port
Extension fitting 	M5 male x M5 female	MS-5J	Extends piping to prevent interference with fittings
Nipple 	M5 male x M5 male	MS-5N	Connects a fitting to equipment or another fitting
Universal nipple 	M5 male x M5 male PAT	MS-5UN	Unrestricted positions and connection at 360° around the stud axis
Barb tee for soft tube 	ø3.18/2.18 x M5	MS-5ATHU-3	For piping soft nylon tubing
	ø3.18/2 x M5		For piping polyurethane tubing
	ø4/2.5 x M5	MS-5ATHU-4	Unrestricted 360° positioning and fastening around the stud axis
ø6/4 x M5	MS-5ATHU-6		
Gasket (H) 	Material: Nylon 66 GF30%	M-5GH	Used only with: MS-5ALHU-6 MS-5HLH-4 MS-5HLH-6 MS-5ATHU-6

Related Equipment Tubing

Nylon Tubing

Series T

Model	T0425	T0403	T0604	T0645	T0806	T1075	T1209	T1613
Fluid	Air, Water							
Max. operating pressure (at 20°C)	1.5MPa							
Burst pressure	Refer to series T burst pressure characteristics curve. ^{Note)}							
Min. bending radius mm	13	25	24	36	48	60	75	100
Operating temperature	-20 to 60°C, With water: 0 to 40°C (with no freezing)							
Material	Nylon 12							

Note) Best Pneumatics No.4, page 2.4-1

20m roll

O.D.	I.D.	Color (color symbol)	Model	
4	2.5	Black (B)	T0425 Color symbol-20	
		White (W)		
		Red (R)		
		Blue (BU)		
		Yellow (Y)		
		Green (G)		
	3	Black (B)	T0403	
		White (W)	Color symbol-20	
	6	4	Black (B)	T0604 Color symbol-20
			White (W)	
			Red (R)	
			Blue (BU)	
4.5		Yellow (Y)	Color symbol-20	
		Green (G)		
8	6	Black (B)	T0806 Color symbol-20	
		White (W)		
		Red (R)		
		Blue (BU)		
	6	Yellow (Y)	Color symbol-20	
		Green (G)		
10	7.5	Black (B)	T1075 Color symbol-20	
		White (W)		
		Red (R)		
		Blue (BU)		
12	9	White (W)	T1209 Color symbol-20	
		Red (R)		
		Blue (BU)		
		Yellow (Y)		
16	13	Green (G)	T1613 Color symbol-20	
		Black (B)		
		White (W)		

100m roll

O.D.	I.D.	Color (color symbol)	Model
4	2.5	Black (B)	T0425
		White (W)	Color symbol-100
6	4	Black (B)	T0604
		White (W)	Color symbol-100
8	6	Black (B)	T0806
		White (W)	Color symbol-100
10	7.5	Black (B)	T1075
		White (W)	Color symbol-100
12	9	Black (B)	T1209
		White (W)	Color symbol-100
16	13	Black (B)	T1613
		White (W)	Color symbol-100*

* T1613 is on a reel.

Polyurethane Tubing

Series TU

Model	TU0425	TU0604	TU0805	TU1065	TU1208
Fluid	Air, Water				
Max. operating pressure (at 20°C)	0.8MPa				
Burst pressure	Refer to series TU burst pressure characteristics curve. ^{Note)}				
Min. bending radius mm	10	15	20	27	35
Operating temperature	-20 to 60°C, With water: 0 to 40°C (with no freezing)				
Material	Polyurethane				

Note) Best Pneumatics No.4, page 2.4-3

20m roll

O.D.	I.D.	Color (color symbol)	Model	
4	2.5	Black (B)	TU0425 Color symbol-20	
		White (W)		
		Red (R)		
		Blue (BU)		
		Yellow (Y)		
		Green (G)		
	6	4	Clear (C)	TU0604 Color symbol-20
			Orange (YR)	
	6	4	Black (B)	TU0805 Color symbol-20
			White (W)	
			Red (R)	
			Blue (BU)	
5		Yellow (Y)	Color symbol-20	
		Green (G)		
10	6.5	Clear (C)	TU1065 Color symbol-20	
		Orange (YR)		
		Black (B)		
		White (W)		
12	8	Red (R)	TU1208 Color symbol-20	
		Blue (BU)		
		Yellow (Y)		
		Green (G)		
		Clear (C)		
		Orange (YR)		

100m roll

O.D.	I.D.	Color (color symbol)	Model	
4	2.5	Black (B)	TU0425 Color symbol-100	
		White (W)		
		Red (R)		
		Blue (BU)		
		Yellow (Y)		
		Green (G)		
	6	4	Clear (C)	TU0604 Color symbol-100
			Orange (YR)	
	6	4	Black (B)	TU0805 Color symbol-100
			White (W)	
			Red (R)	
			Blue (BU)	
5		Yellow (Y)	Color symbol-100	
		Green (G)		
10	6.5	Clear (C)	TU1065 Color symbol-100	
		Orange (YR)		
		Black (B)		
		White (W)		
12	8	Red (R)	TU1208 Color symbol-100	
		Blue (BU)		
		Yellow (Y)		
		Green (G)		
		Clear (C)		
		Orange (YR)		

Related Equipment

Floating Joint/Stainless Steel Type

Series JS



Refer to SMC Information No. 99-E475 for details.

Stainless steel used for improved corrosion resistance

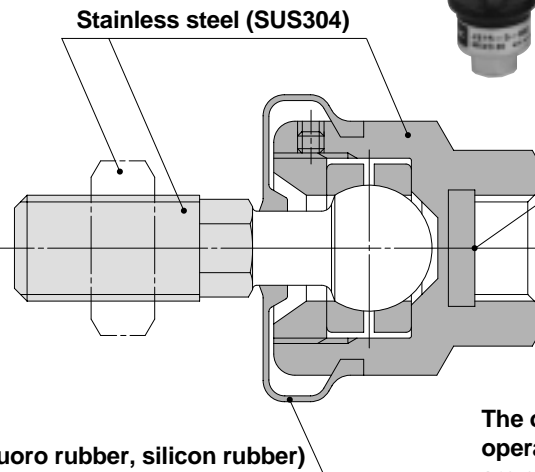
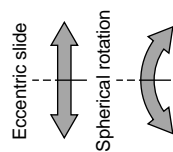
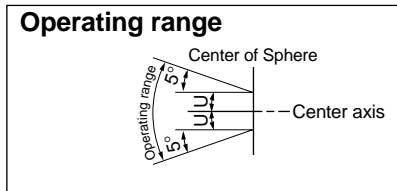

Dust cover (fluoro rubber, silicon rubber)

- The shape of the cover prevents residual liquid.
- Improved sealing

The overall length and maximum operating tension and compression are equivalent to the standard type (series JA).

Models and Specifications

Model	Applicable cylinder bore size (mm) ^{Note 1)}	Applicable cylinder nominal thread size	Max. tension and compression N	Allowable eccentricity U	Operating pressure		Ambient temperature
					Pneumatic cylinder	Hydraulic cylinder	
JS10-4-070	10	M4 x 0.7	80	0.5	1MPa or less	3.5MPa or less ^{Note 2)}	-5 to 60°C
JS16-5-080	10, 16	M5 x 0.8	210	0.5			
JS20-8-125	20	M8 x 1.25	1100	0.5			
JS32-10-125	25, 32	M10 x 1.25	2500	0.5			
JS40-14-150	40	M14 x 1.5	6000	0.75			
JS63-18-150	50, 63	M18 x 1.5	11000	1			

Note 1) Use the applicable bore sizes as a guide. For details, consult the catalog of the cylinder being used for the rod end thread size.

Note 2) For 3.5MPa hydraulic cylinders, operate within the maximum tension and compression force.

How to Order

J S 32 10-125

Stainless steel type

Applicable bore size (mm)

Symbol	Applicable cylinder bore size (mm)
10	10
16	10, 16
20	20
32	25, 32
40	40
63	50, 63

Nominal thread size

Symbol	Applicable cylinder nominal thread size
4-070	M4 x 0.7
5-080	M5 x 0.8
8-125	M8 x 1.25
10-125	M10 x 1.25
14-150	M14 x 1.5
18-150	M18 x 1.5

Dust cover material

Symbol	Material
Nil	Fluoro rubber
S	Silicon rubber

Technical Data

Chemical Resistance Table

A : No influence or almost no influence
 B : Some influence, but operational depending on conditions
 C : Avoid use if possible
 D : Substantial influence, not suitable for use
 - : Not tested

Chemical Resistance Table

Parts			Body		Seal		Water resistant auto switch	
Material			Stainless steel	Aluminum	Nitrile rubber	Fluoro rubber	Resin casing	Lead wire
Chemical (Concentration weight %, Temperature °C)			SUS304	Al	NBR (-10 to 60°C)	FKM (-40 to 150°C)	PBT (-10 to 60°C)	PVC (-10 to 60°C)
	Symbol							
Inorganic salt	1	Hydrochloric acid (20%, Room temperature)	D	D	B	A	A	B
	2	Chromic acid (25%, 70°C)	B	D	D	A	A	B
	3	Boric acid	B	D	A	A	A	B
	4	Sulfuric acid (30%, Room temperature)	D	D	A	A	A	B
	5	Phosphoric acid (50%, Room temperature)	B	D	A	A	A	B
Inorganic alkali	6	Ammonium hydroxide	B	B	D	A	A	B
	7	Sodium hydroxide (30%, Room temperature)	A	D	A	C	A	D
	8	Calcium hydroxide	C	D	A	A	A	A
Organic solvent	9	Magnesium hydroxide	B	B	A	A	A	A
	10	Acetylene	A	A	A	A	A	A
	11	Formic acid (25%, Room temperature)	B	C	D	C	C	C
	12	Citric acid	C	D	A	A	C	B
	13	Acetic acid (10%, Room temperature)	A	C	C	B	A	B
Other (oil, gas, etc.)	14	Lactic acid (5%, 20°C)	B	D	A	A	A	B
	15	Linseed oil	A	B	A	A	C	C
	16	Potassium chloride	B	C	A	A	A	A
	17	Calcium chloride	B	A	A	A	A	A
	18	Mineral oil	A	A	A	A	A	C
	19	Sodium hypochlorite (2%, Room temperature)	B	D	D	A	A	C
	20	Sodium chloride	B	—	A	A	A	A
	21	Carbon dioxide	A	A	A	A	A	A
	22	Natural gas	A	A	A	A	A	A
	23	Boric acid	B	D	A	A	A	B

* Unless noted otherwise, the solution concentration is in a saturated state.

* Chemical resistance is a guide that applies only to the stainless steel cylinder parts, and does not guarantee the performance of air cylinders (auto switches). Be sure to perform a verification test before operating.

* The temperature range for the protective label cover is between -40 to 110°C, and the temperature range for grease is between -20 to 150°C. (However, there is no relationship with the chemicals listed above.)





Series CJ5-S/CG5-S

Safety Instructions

These safety instructions are intended to prevent a hazardous situation and/or equipment damage. These instructions indicate the level of potential hazard by a label of "**Caution**", "**Warning**" or "**Danger**". To ensure safety, be sure to observe ISO 4414 Note 1), JIS B 8370 Note 2) and other safety practices.

 **Caution** : Operator error could result in injury or equipment damage.

 **Warning** : Operator error could result in serious injury or loss of life.

 **Danger** : In extreme conditions, there is a possible result of serious injury or loss of life.

Note 1) ISO 4414: Pneumatic fluid power – Recommendations for the application of equipment to transmission and control systems

Note 2) JIS B 8370: General Rules for Pneumatic Equipment

Warning

1. The compatibility of pneumatic equipment is the responsibility of the person who designs the pneumatic system or decides its specifications.

Since the products specified here are used in various operating conditions, their compatibility for the specific pneumatic system must be based on specifications or after analysis and/or tests to meet your specific requirements.

2. Only trained personnel should operate pneumatically operated machinery and equipment.

Compressed air can be dangerous if handled incorrectly. Assembly, handling or repair of pneumatic systems should be performed by trained and experienced operators.

3. Do not service machinery/equipment or attempt to remove components until safety is confirmed.

1. Inspection and maintenance of machinery/equipment should only be performed after confirmation of safe locked-out control positions.
2. When equipment is to be removed, confirm the safety process as mentioned above. Cut the supply pressure for this equipment and exhaust all residual compressed air in the system.
3. Before machinery/equipment is restarted, take measures to prevent shooting-out of cylinder piston rod, etc. (Bleed air into the system gradually to create back pressure.)

4. Contact SMC if the product is to be used in any of the following conditions:

1. Conditions and environments beyond the given specifications, or if product is used outdoors.
2. Installation on equipment in conjunction with atomic energy, railway, air navigation, vehicles, medical equipment, food and beverages, recreation equipment, emergency stop circuits, press applications, or safety equipment.
3. An application which has the possibility of having negative effects on people, property, or animals, requiring special safety analysis.



Actuator Common Precautions 1

Be sure to read before handling.

For detailed individual precautions on each series, refer to the main catalog sections.

Design

Warning

1. There is a danger of sudden action by air cylinders if sliding parts of machinery are twisted, etc., and changes in forces occur.

In such cases, human injury may occur; e.g., by catching hands or feet in the machinery, or damage to the machinery itself may occur. Therefore, the machine should be designed to avoid such dangers.

2. Install a protective cover when there is a risk of human injury.

If a driven object and moving parts of a cylinder pose a danger of human injury, design the structure to avoid contact with the human body.

3. Securely tighten all stationary parts and connected parts so that they will not become loose.

Especially when a cylinder operates with high frequency or is installed where there is a lot of vibration, ensure that all parts remain secure.

4. A deceleration circuit may be required.

When a driven object is operated at high speed or the load is heavy, a cylinder's cushion will not be sufficient to absorb the impact. Install a deceleration circuit to reduce the speed before cushioning to relieve the impact. In this case, the rigidity of the machinery should also be examined.

5. Consider a possible drop in operating pressure due to a power outage, etc.

When a cylinder is used in a clamping mechanism, there is a danger of work pieces dropping if there is a decrease in clamping force due to a drop in circuit pressure caused by a power outage, etc. Therefore, safety equipment should be installed to prevent damage to machinery and/or human injury. Suspension mechanisms and lifting devices also require consideration for drop prevention.

6. Consider a possible loss of power source.

Measures should be taken to protect against human injury and equipment damage in the event that there is a loss of power to equipment controlled by air pressure, electricity or hydraulics, etc.

7. Design circuitry to prevent sudden lurching of driven objects.

When a cylinder is driven by an exhaust center type directional control valve or when starting up after residual pressure is exhausted from the circuit, etc., the piston and its driven object will lurch at high speed if pressure is applied to one side of the cylinder because of the absence of air pressure inside the cylinder. Therefore, select equipment and design circuits to prevent sudden lurching, because there is a danger of human injury and/or damage to equipment when this occurs.

8. Consider emergency stops.

Design so that human injury and/or damage to machinery and equipment will not be caused when machinery is stopped by a safety device under abnormal conditions, such as a power outage or a manual emergency stop.

9. Consider the action when operation is restarted after an emergency stop or abnormal stop.

Design the machinery so that human injury or equipment damage will not occur upon restart of operation. When the cylinder has to be reset at the starting position, install safe manual control equipment.

Selection

Warning

1. Confirm the specifications.

The products advertised in this catalog are designed according to use in industrial compressed air systems. If the products are used in conditions where pressure, temperature, etc., are out of specification, damage and/or malfunction may be caused. Do not use in these conditions. (Refer to specifications.)

Consult SMC if you use a fluid other than compressed air.

2. Intermediate stops

When intermediate stopping of a cylinder piston is performed with a 3 position closed center type directional control valve, it is difficult to achieve stopping positions as accurate and precise as with hydraulic pressure due to the compressibility of air.

Furthermore, since valves and cylinders, etc., are not guaranteed for zero air leakage, it may not be possible to hold a stopped position for an extended period of time. Contact SMC in case it is necessary to hold a stopped position for an extended period.

Caution

1. Operate within the limits of the maximum usable stroke.

The piston rod will be damaged if operated beyond the maximum stroke. Refer to the air cylinder model selection procedure for the maximum useable stroke.

2. Operate the piston within a range such that collision damage will not occur at the stroke end.

Operate within a range such that damage will not occur when the piston having inertial force stops by striking the cover at the stroke end. Refer to the cylinder model selection procedure for the range within which damage will not occur.

3. Use a speed controller to adjust the cylinder drive speed, gradually increasing from a low speed to the desired speed setting.

4. Provide intermediate supports for long stroke cylinders.

Provide intermediate supports for cylinders with long strokes to prevent rod damage due to sagging of the rod, deflection of the tube, vibration and external loads, etc.



Actuator Common Precautions 2

Be sure to read before handling.

For detailed individual precautions on each series, refer to the main catalog sections.

Mounting

⚠ Caution

1. Be certain to align the rod axis with the load and direction of movement when connecting.

When not properly aligned, the rod and tube may be twisted, and damage may be caused due to wear on areas such as the inner tube surface, bushings, rod surface and seals.

2. When an external guide is used, connect the rod end and the load in such a way that there is no interference at any point within the stroke.

3. Do not scratch or gouge the sliding parts of the cylinder tube or piston rod, etc., by striking or grasping them with other objects.

Cylinder bores are manufactured to precise tolerances, so that even a slight deformation may cause malfunction. Also, scratches or gouges, etc., in the piston rod may lead to damaged seals and cause air leakage.

4. Prevent the seizure of rotating parts.

Prevent the seizure of rotating parts (pins, etc.) by applying grease.

5. Do not use until you can verify that equipment can operate properly.

Verify correct mounting by appropriate function and leakage inspections after compressed air and power are connected following mounting, maintenance or conversions.

6. Instruction manual

The product should be mounted and operated after thoroughly reading the manual and understanding its contents.

Keep the instruction manual where it can be referred to as needed.

Piping

⚠ Caution

1. Preparation before piping

Before piping is connected, it should be thoroughly blown out with air (flushing) or washed to remove chips, cutting oil and other debris from inside the pipe.

2. Wrapping of pipe tape

When screwing together pipes and fittings, etc., be certain that chips from the pipe threads and sealing material do not get inside the piping.

Also, when pipe tape is used, leave 1.5 to 2 thread ridges exposed at the end of the threads.

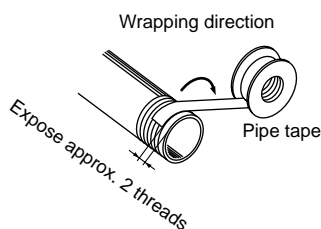

Cushion

⚠ Caution

1. Readjust using the cushion needle.

Cushion is adjusted at the factory, however, the cushion needle on the cover should be readjusted when the product is put into service, based upon factors such as the size of the load and the operating speed. When the cushion needle is turned clockwise, the restriction becomes smaller and the cushion's effectiveness is increased. Tighten the lock nut securely after adjustment is performed.

2. Do not operate with the cushion needle in a fully closed condition.

This will cause damage to the seals.

Air Supply

⚠ Warning

1. Use clean air.

Do not use compressed air which includes chemicals, synthetic oils containing organic solvents, salt or corrosive gases, etc., as it can cause damage or malfunction.

⚠ Caution

1. Install air filters.

Install air filters at the upstream side of valves. The filtration degree should be 5µm or finer.

2. Install an after cooler, air dryer or water separator, etc.

Air that includes excessive drainage may cause malfunction of valves and other pneumatic equipment. To prevent this, install an after cooler, air dryer or water separator, etc.

3. Use the product within the specified range of fluid and ambient temperature.

Take measures to prevent freezing, since moisture in circuits can be frozen under 5°C, and this may cause damage to seals and lead to malfunction.

Refer to SMC's "Air Cleaning Equipment" catalog for further details on compressed air quality.

Maintenance

⚠ Warning

1. Removal of equipment, and supply/exhaust of compressed air.

When equipment is removed, first check measures to prevent dropping of driven objects and run-away of equipment, etc. Then cut off the supply pressure and electric power, and exhaust all compressed air from the system.

When machinery is restarted, proceed with caution after confirming measures to prevent cylinder lurching.

⚠ Caution

1. Drain flushing

Remove drainage from air filters regularly. (Refer to specifications.)



Stainless Steel Cylinder Series CJ5-S/CG5-S

Specific Product Precautions

Be sure to read before handling.

Refer to pages 29 through 31 for safety instructions and actuator common precautions.

Design

⚠ Warning

1. Note the weight of the stainless steel products.

Since the weight of stainless steel cylinders is approximately 1.5 to 3 times heavier than the standard products (with aluminum body), be careful when calculating weight estimates. Also, when mounting the cylinder on equipment where vibration is expected, avoid using single side brackets such as the flange type, and use double side brackets such as the foot type instead.

Selection

⚠ Warning

1. Generally, use nitrile rubber (NBR) seals with liquids that do not contain chlorine and sulfur, and use fluoro rubber (FKM) seals with liquids that contain chlorine and sulfur.

However, depending on the type and the brand of liquid (such as cleaning solvent) that splashes on the cylinder, the operating life of seals may be reduced dramatically. In cases where special additives are used, or where liquid caused trouble with the conventional nitrile or fluoro rubber seals in the past, request an investigation or set up a test period for the use of the seals.

2. Even the fluoro rubber specification may not be applicable depending on the type of chemicals and the operating temperature. Therefore, be sure to verify the seal's applicability before use.

Mounting

⚠ Warning

1. Do not rotate the cover.

If the cover is rotated when the cylinder is mounted or when fittings are screwed in, it may cause damage from the joint section of the cover.

Operating Environment

⚠ Warning

1. Fully consider the compatibility of stainless steel.

The corrosion resistance of stainless steel is not effective against all media and corrosive environments. Corrosion proceeds rapidly with strong hydrochloric acid, hydrofluoric acid, and high temperature ammonium gas, etc. Therefore its compatibility to the environment must be considered carefully.

2. Do not operate cylinders with auto switches in environments where oil and chemicals are used.

Contact SMC when operating in environments with coolants, cleaning solvents, various oils or chemicals, as it may cause adverse effects (faulty insulation, malfunction due to swelling of the potting resin, and hardening of lead wires, etc) to auto switches even in a short period of time. Even with the fluoro rubber seal specification, the auto switch related parts (switch body, mounting bracket, and built-in magnet) are identical to the standard specifications. Therefore, consult SMC regarding the cylinder's compatibility (such as chemical resistance) with an environment (chemicals, etc.) before operating.

3. Do not immerse the cylinder in water or chemicals.

When the cylinder is operated in a condition with water pressure, the fluid leaks into the cylinder in the early stages. In the worst case, the fluid may back flow inside the piping and damage the solenoid valve.

Maintenance

⚠ Caution

1. If there is a reduction in grease lubrication and reapplication of grease is necessary, use the special grease shown below.

Grease kit part no. for stainless steel cylinders

- GR-R-010 (10g)

Precautions for series CG5-S

1. Sealant* is used on the threads of the connecting sections of the cover and the cylinder tube for air-tight construction. When disassembling the cylinder, the old sealant must be completely removed, and new sealant must be applied before re-assembling.

* Loctite 542 (medium strength) or equivalent

2. ø50 or larger bore size cylinders cannot be disassembled.

When disassembling cylinders with bore sizes of ø20 through ø40, grip the double flat part of either the head cover or the rod cover with a vise and loosen the other side with a wrench or a monkey wrench, etc., and then remove the cover. When re-tightening, tighten approximately 2 degrees more than the original position. (Cylinders with ø50 or larger bore sizes are tightened with a large tightening torque and cannot be disassembled. Contact SMC when disassembly is required.)



Design and Selection

Warning

1. Confirm the specifications.

Read the specifications carefully and use this product appropriately. The product may be damaged or malfunction if it is used outside the range of specifications of current load, voltage, temperature or impact.

2. Take precautions when multiple cylinders are used close together.

When multiple auto switch cylinders are used in close proximity, magnetic field interference may cause the switches to malfunction. Maintain a minimum cylinder separation of 40mm. (When the allowable separation is indicated for each cylinder series, use the specified value.)

3. Pay attention to the length of time that a switch is ON at an intermediate stroke position.

When an auto switch is placed at an intermediate position of the stroke and a load is driven at the time the piston passes, the auto switch will operate, but if the speed is too great the operating time will be shortened and the load may not operate properly. The maximum detectable piston speed is:

$$V(\text{mm/s}) = \frac{\text{Auto switch operating range (mm)}}{\text{Time load applied (ms)}} \times 1000$$

4. Keep wiring as short as possible.

Although wire length should not affect switch function, use wiring 100m or shorter.

5. Take precautions for the internal voltage drop of the switch.

Generally, the internal voltage drop will be greater with a 2 wire solid state switch than a reed switch, and the load supply voltage (subtract the internal voltage drop of the switch from the power supply voltage) becomes lower.

$$\text{Load supply voltage} > \text{Minimum operating voltage of load}$$

If the above requirement is not satisfied, malfunction will occur (will not turn ON). Therefore, confirm the specifications before operating.

* Note that the voltage drop will be large when connected in a serial arrangement.

Also note that a 24VDC relay is not applicable.

Warning

6. Pay attention to leakage current.

With a 2 wire solid state auto switch, current (leakage current) flows to the load to operate the internal circuit even when in the OFF state.

$$\text{Operating current of load (OFF condition)} > \text{Leakage current}$$

If the above requirement is not satisfied, it will not reset correctly (stays ON). Use a 3 wire switch if this specification will not be satisfied.

Furthermore, leakage current flow to the load will be "n" times larger when "n" auto switches are connected in parallel.

7. Do not use a load that generates surge voltage.

Although a zener diode for surge protection is connected at the output side of a solid state auto switch, damage may still occur if the surge is applied repeatedly. When a load, such as a relay or solenoid valve, which generates surge is directly driven, use a type of switch with a built-in surge absorbing element.

8. Cautions for use in an interlock circuit

When an auto switch is used for an interlock signal requiring high reliability, devise a double interlock system to avoid trouble by providing a mechanical protection function, or by also using another switch (sensor) together with the auto switch. Also perform periodic maintenance and confirm proper operation.

9. Ensure sufficient clearance for maintenance activities.

When designing an application, be sure to allow sufficient clearance for maintenance and inspections.



Stainless Steel Cylinder

Water Resistant Auto Switch Precautions 2

Be sure to read before handling.

Mounting and Adjustment

Warning

1. Do not drop or bump.

Do not drop, bump or apply excessive impacts (1000m/s² or more for solid state switches) while handling.

Although the body of the switch may not be damaged, the inside of the switch could be damaged and cause a malfunction.

2. Do not carry a cylinder by the auto switch lead wires.

Never carry a cylinder by its lead wires. This may not only cause broken lead wires, but it may cause internal elements of the switch to be damaged by the stress.

3. Mount switches using the proper tightening torque.

When a switch is tightened beyond the range of tightening torque, the mounting screws, mounting bracket or switch may be damaged.

On the other hand, tightening below the range of tightening torque may allow the switch to slip out of position.

4. Mount a switch at the center of the operating range.

Adjust the mounting position of an auto switch so that the piston stops at the optimum operating position (at the center of the operating range where the green LED lights up). (The mounting positions shown in the catalog indicate the optimum positions at stroke end.) If mounted at the end of the operating range (around the borderline of ON and OFF), operation may be unstable.

Wiring

Warning

1. Avoid repeatedly bending or stretching lead wires.

Broken lead wires will result from repeatedly applying bending stress or stretching force to the lead wires.

2. Be sure to connect the load before power is applied.

If the power is turned ON when an auto switch is not connected to a load, the switch will be instantly damaged because of excess current.

3. Confirm proper insulation of wiring.

Be certain that there is no faulty wiring insulation (contact with other circuits, ground fault, improper insulation between terminals, etc.). Damage may occur due to excess current flow into a switch.

4. Do not wire with power lines or high voltage lines.

Wire separately from power lines or high voltage lines, avoiding parallel wiring or wiring in the same conduit with these lines. Control circuits containing auto switches may malfunction due to noise from these other lines.

5. Avoid incorrect wiring.

The switch will not be damaged if protected by a protection circuit, but the switch will be in a normally ON state. However, note that the switch will be damaged if reversed connections are made while the load is in a short circuited condition.

* Lead wire color changes

Lead wire colors of SMC auto switches have been changed in order to meet NECA Standard 0402 for production beginning September, 1996 and thereafter. Please refer to the table provided.

Special care should be taken regarding wire polarity during the time that the old colors still coexist with the new colors.

2 wire

	Old	New
Output (+)	Red	Brown
Output (-)	Black	Blue



Stainless Steel Cylinder Water Resistant Auto Switch Precautions 3

Be sure to read before handling.

Operating Environment

Warning

1. Never use in an atmosphere of explosive gases.

The structure of auto switches is not intended to prevent explosion. Never use in an atmosphere with an explosive gas since this may cause a serious explosion.

2. Do not use in an area where a magnetic field is generated.

Auto switches will malfunction or magnets inside cylinders will become demagnetized.

3. Operating in environments where the switch is constantly exposed to water (including various solvents and chemicals)

Water resistant auto switches can be operated in environments with constant water splashing. However, additives included in oil, cleaning solvent, and chemicals can cause adverse effects, such as swelling, melting, and drop in mechanical strength, to the internal insulation material (potting resin) and the external components of the switch.

4. Operating in environments with temperature cycles

When a liquid at a temperature that is different (use 20°C or more as a guide) from the ambient temperature repeatedly splashes on the switch, temperature cycles are repeatedly applied to the switch and may cause adverse effects to its internal components.

5. Do not use in an area where surges are generated.

When there are units (solenoid type lifter, high frequency induction furnace, motor, etc.) which generate a large amount of surge in the area around cylinders with solid state auto switches, this may cause deterioration or damage to internal circuit elements of the switch. Avoid sources of surge generation and disorganized lines.

6. Avoid accumulation of iron debris or close contact with magnetic substances.

When a large amount of ferrous debris such as machining chips or welding spatter is accumulated, or a magnetic substance (something attracted by a magnet) is brought into close proximity with an auto switch cylinder, it may cause auto switches to malfunction due to a loss of the magnetic force inside the cylinder.

Maintenance

Warning

1. Perform the following maintenance periodically in order to prevent possible danger due to unexpected auto switch malfunction.

- 1) Securely tighten switch mounting screws.

If screws become loose or the mounting position is dislocated, retighten them after readjusting the mounting position.

- 2) Confirm that there is no damage to lead wires.

To prevent faulty insulation, replace switches or repair lead wires, etc., if damage is discovered.

- 3) Confirm the lighting of the green light on a 2 color indicator type switch.

Confirm that the green LED is on when stopped at the established position. If the red LED is on, the mounting position is not appropriate. Readjust the mounting position until the green LED lights up.

Other

Warning

1. Consult SMC concerning water resistance, flexibility of lead wires and usage at welding sites, etc.

SMC'S GLOBAL MANUFACTURING, DISTRIBUTION AND SERVICE NETWORK

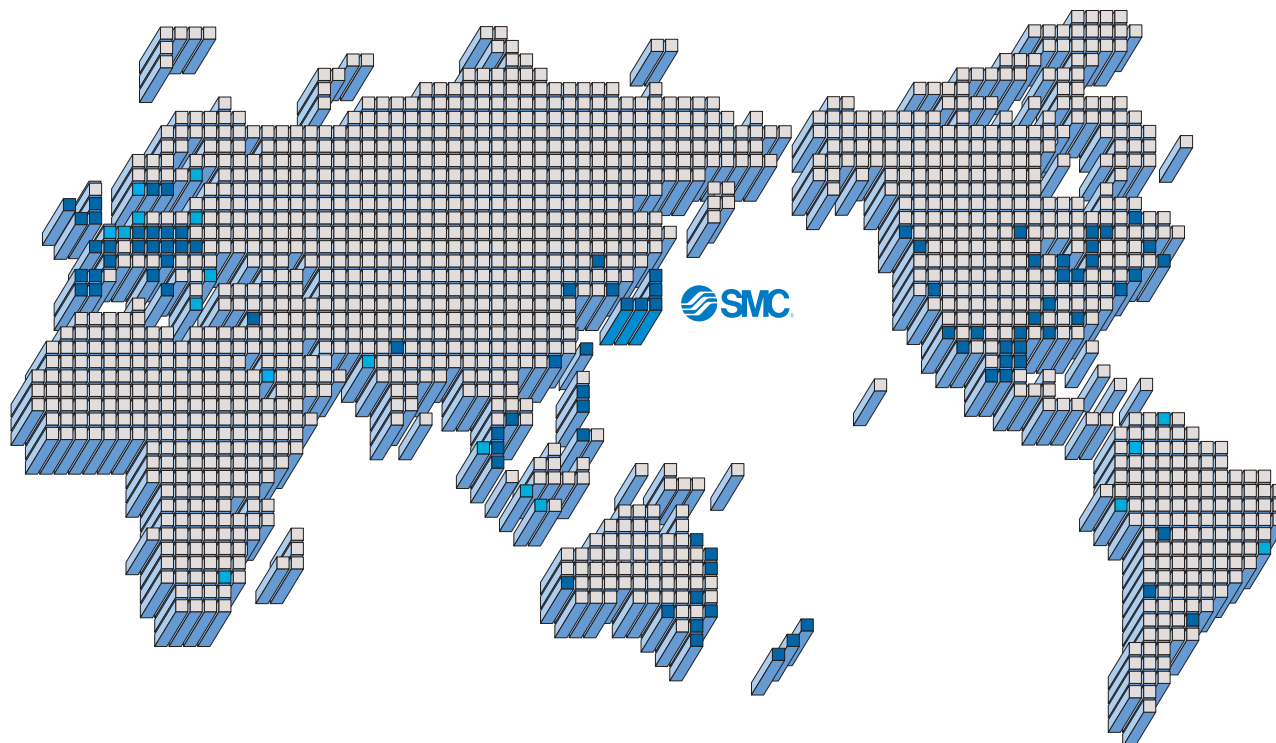

EUROPE

AUSTRIA

SMC Pneumatik GmbH

CZECH

SMC Industrial Automation CZ s.r.o.

DENMARK

SMC Pneumatik A/S

FINLAND

SMC Pneumatics Finland Oy

FRANCE

SMC Pneumatique SA

GERMANY

SMC Pneumatik GmbH

HUNGARY

SMC Hungary Ipari Automatizálási Kft.

IRELAND

SMC Pneumatics (Ireland) Ltd.

ITALY

SMC Italia S.p.A.

NETHERLANDS

SMC Pneumatics BV.

NORWAY

SMC Pneumatics Norway A/S

POLAND

SMC Industrial Automation Polska Sp.z.o.o.

ROMANIA

SMC Romania s.r.l.

RUSSIA

SMC Pneumatik LLC.

SLOVAKIA

SMC Priemyselná automatizácia, s.r.o.

EUROPE

SLOVENIA

SMC Industrijska Avtomatika d.o.o.

SPAIN/PORTUGAL

SMC España, S.A.

SWEDEN

SMC Pneumatics Sweden AB

SWITZERLAND

SMC Pneumatik AG.

UK

SMC Pneumatics (U.K.) Ltd.

ASIA

CHINA

SMC (China) Co., Ltd.

HONG KONG

SMC Pneumatics (Hong Kong) Ltd.

INDIA

SMC Pneumatics (India) Pvt. Ltd.

MALAYSIA

SMC Malaysia (S.E.A.) Sdn. Bhd.

PHILIPPINES

SMC Pneumatics (Philippines), Inc.

SINGAPORE

SMC Pneumatics (S.E.A.) Pte. Ltd.

SOUTH KOREA

SMC Pneumatics Korea Co., Ltd.

TAIWAN

SMC Pneumatics (Taiwan) Co., Ltd.

THAILAND

SMC Thailand Ltd.

NORTH AMERICA

CANADA

SMC Pneumatics (Canada) Ltd.

MEXICO

SMC Corporation (Mexico) S.A. de C.V.

USA

SMC Corporation of America

SOUTH AMERICA

ARGENTINA

SMC Argentina S.A.

BOLIVIA

SMC Pneumatics Bolivia S.R.L.

BRAZIL

SMC Pneumaticos Do Brazil Ltda.

CHILE

SMC Pneumatics (Chile) S.A.

VENEZUELA

SMC Neumatica Venezuela S.A.

OCEANIA

AUSTRALIA

SMC Pneumatics (Australia) Pty. Ltd.

NEW ZEALAND

SMC Pneumatics (N.Z.) Ltd.

SMC Corporation

1-16-4 Shimbashi, Minato-ku, Tokyo 105-0004, JAPAN

Tel: 03-3502-2740 Fax: 03-3508-2480

URL <http://www.smcworld.com>

© 2003 SMC CORPORATION All Rights Reserved

1st printing August, 2003 D-YGA P-120 (YG)

This catalog is printed on recycled paper with concern for the global environment.

All specifications in this catalog are subject to change without notice.

Printed in Japan.