

In-line Air Filter (Bidirectional Acquisition Type)

New

RoHS

Operating pressure range **-100 kPa to 0.5 MPa**

Able to capture foreign matter in both vacuum adsorption and vacuum release directions
Prevents foreign matter from scattering again

Filtration **5 μm**

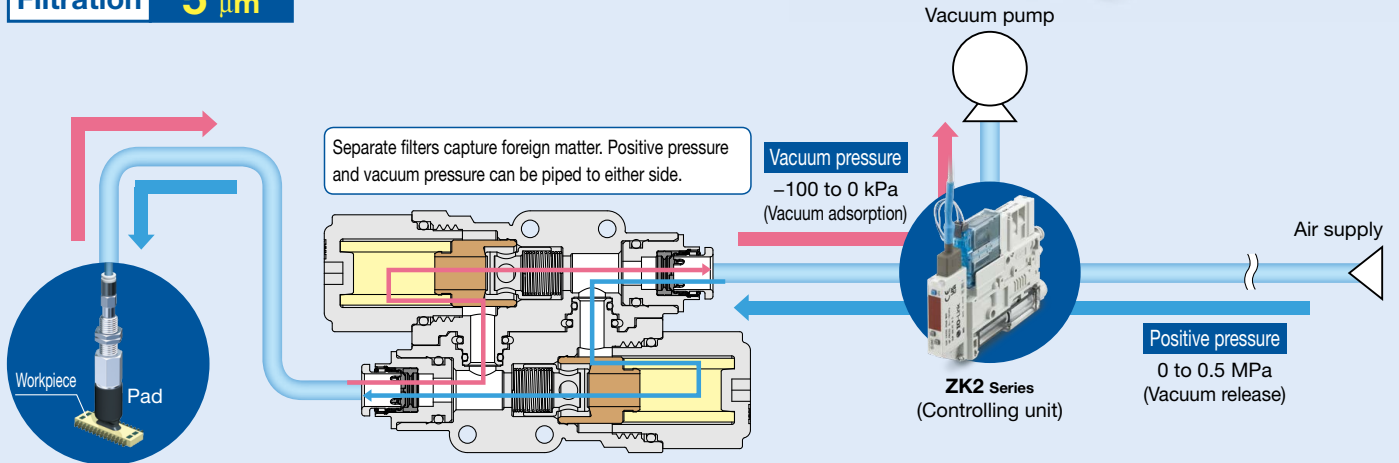

Product configuration

Transparent case (Polycarbonate)

Allows easy inspection of foreign matter on the element

Can remove the case without using tools (thread connection)

Element replacement can easily be done. Use of a hexagon wrench is also possible.

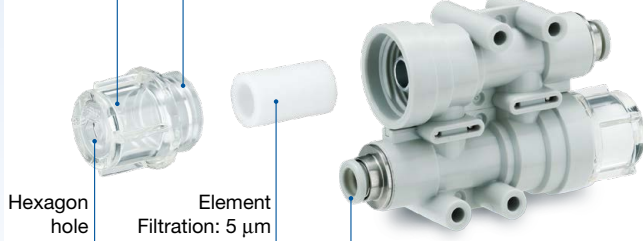

With one-touch fitting

ø4, ø6, ø8

Made to order

- Different diameters
- Filtration: 10 μm (White element)
- Blue element (Filtration: 5 μm)



Option

With holder



Space saving

Reduced piping work and number of parts
Installation area: **41% reduction**

New

In-line air filter
(Bidirectional acquisition type)

In-line air filter x 2 pcs.
Check valve x 2 pcs.
Union tee x 2 pcs.,
Union elbow x 2 pcs.

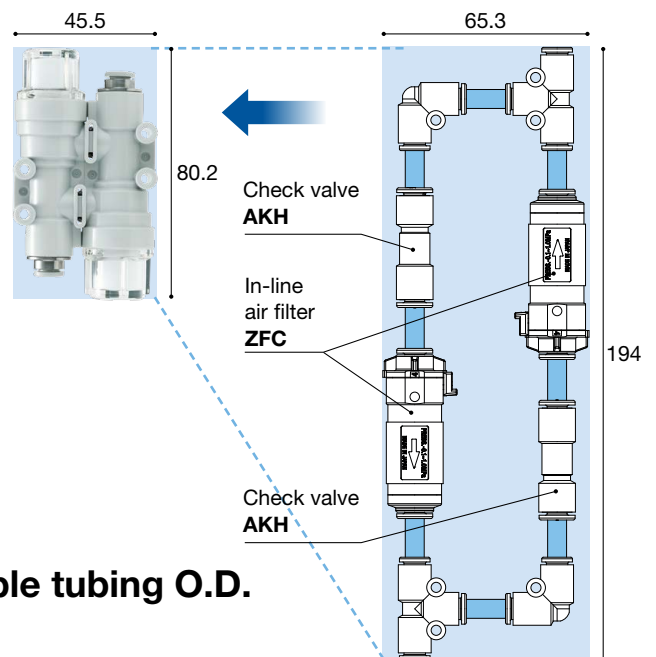

Check valve enclosure

Flow order: Filter → Check valve
Prevents foreign matter from getting caught in the check valve

Applicable tubing O.D.

ø4, ø6, ø8

ZFD Series



CAT.ES100-173A

In-line Air Filter (Bidirectional Acquisition Type) **ZFD Series**

RoHS



How to Order

ZFD 5 **4** - **H** -

Applicable tubing O.D.
Metric size

Symbol	Applicable tubing O.D.
3	ø4
4	ø6
5	ø8

Made to order
Refer to page 2 for details.

Symbol	Specifications
X01	Different diameters
X03	Blue element (Filtration: 5 µm)
X04	Filtration: 10 µm (White element)

Option

Nil	None
H	With holder

Specifications

Model	ZFD53	ZFD54	ZFD55
Port size: Metric size (Applicable tubing O.D.)	ø4	ø6	ø8
Ambient and fluid temperatures	Air		
Operating and ambient temperature range [°C]	0 to 50		
Proof pressure [MPa]	0.5		
Operating pressure range [kPa]	-100 to 0		
Vacuum release pressure [MPa]	0.5 or less		
Filtration [µm]	5		
Case material	Polycarbonate		
Weight [g]	34	33	35

Flow Rate Characteristics

ZFD53: ø4 (Negative pressure)

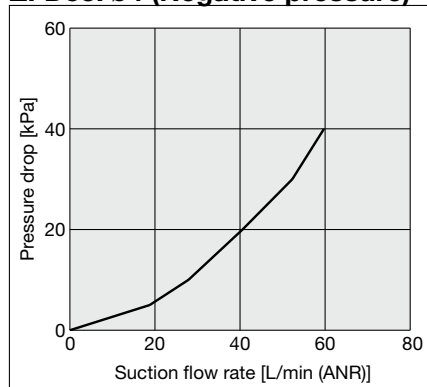

ZFD54: ø6 (Negative pressure)

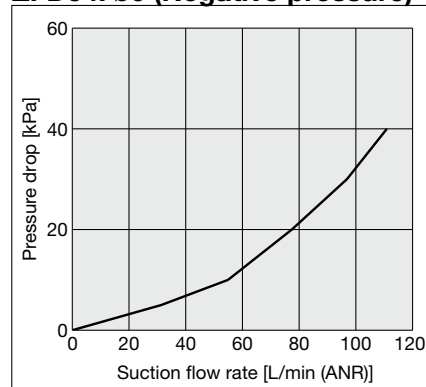

ZFD55: ø8 (Negative pressure)

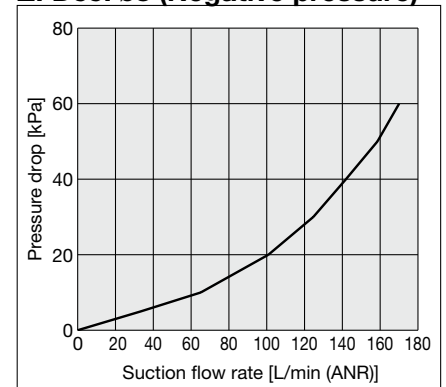

ZFD53: ø4 (Positive pressure)

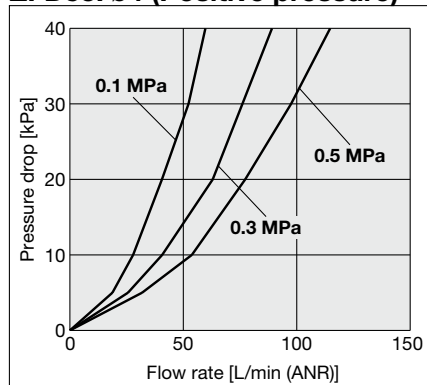

ZFD54: ø6 (Positive pressure)

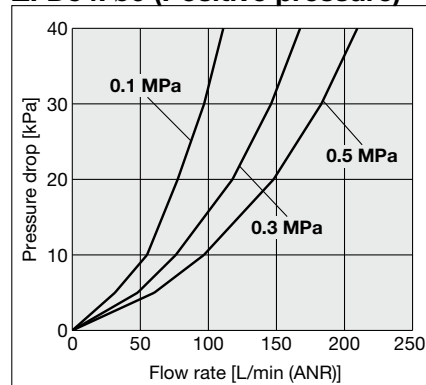

ZFD55: ø8 (Positive pressure)

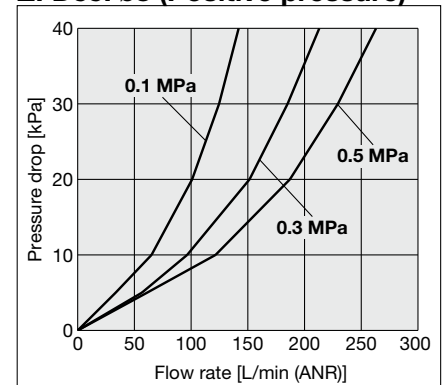



Dimensions

ZFD53/54/55

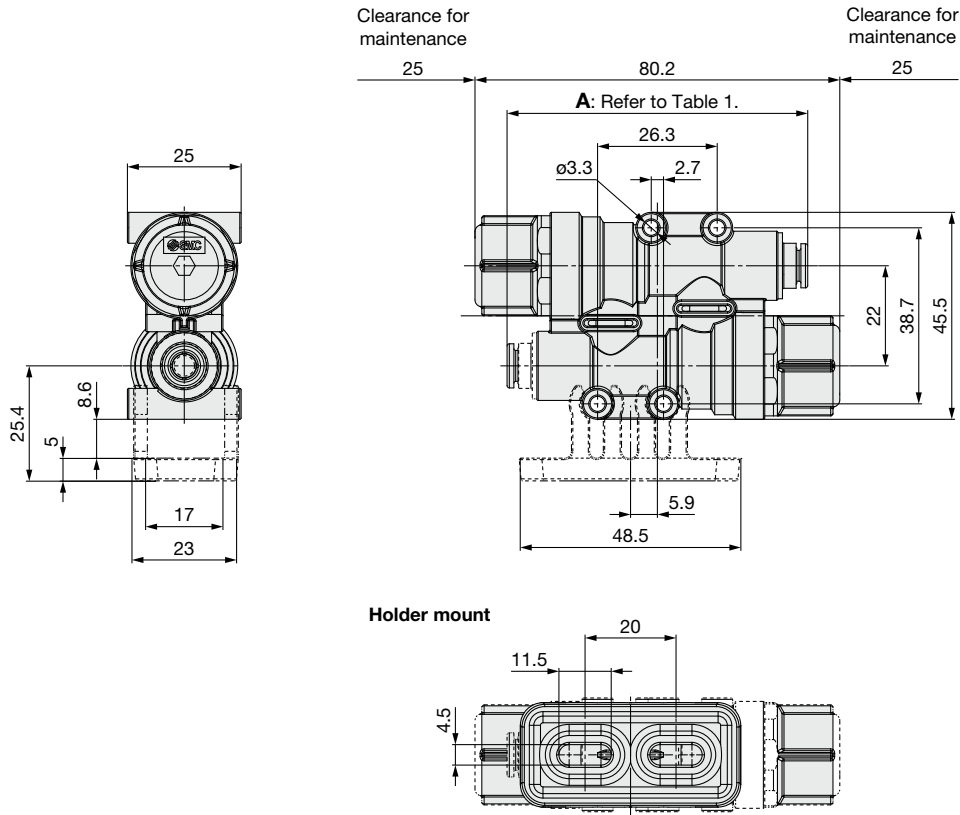

Table 1. Dimension A

Model	ZFD53	ZFD54	ZFD55
Dimensions			



Made to Order

* Please contact SMC for detailed dimensions, specifications and lead times.

1 Different diameters Symbol **-X01**

ZFD 5 **4** - **X01**

Applicable tubing O.D.

Symbol	Applicable tubing O.D.
4	ø6-ø4
5	ø8-ø6

Option

Nil	None
H	With holder

• Different diameters

3 Filtration: 10 μm Symbol **-X04**

Standard product - **X04**

• Filtration: 10 μm

Replacement Element Part No. (Element: 1 pc.)

Part no.
ZFC-EL017

2 Blue element Symbol **-X03**

Easy to recognize white foreign matter on the element by coloring the element.

Standard product - **X03**

• Blue element

Replacement Element Part No. (Element: 1 pc.)

Part no.
ZFC-EL015

Safety Instructions

These safety instructions are intended to prevent hazardous situations and/or equipment damage. These instructions indicate the level of potential hazard with the labels of “**Caution**,” “**Warning**” or “**Danger**.” They are all important notes for safety and must be followed in addition to International Standards (ISO/IEC)*1), and other safety regulations.

 **Danger :** **Danger** indicates a hazard with a high level of risk which, if not avoided, will result in death or serious injury.

 **Warning:** **Warning** indicates a hazard with a medium level of risk which, if not avoided, could result in death or serious injury.

 **Caution:** **Caution** indicates a hazard with a low level of risk which, if not avoided, could result in minor or moderate injury.

*1) ISO 4414: Pneumatic fluid power - General rules and safety requirements for systems and their components
ISO 4413: Hydraulic fluid power - General rules and safety requirements for systems and their components
IEC 60204-1: Safety of machinery - Electrical equipment of machines - Part 1: General requirements
ISO 10218-1: Robots and robotic devices - Safety requirements for industrial robots - Part 1: Robots etc.

Warning

1. The compatibility of the product is the responsibility of the person who designs the equipment or decides its specifications.

Since the product specified here is used under various operating conditions, its compatibility with specific equipment must be decided by the person who designs the equipment or decides its specifications based on necessary analysis and test results. The expected performance and safety assurance of the equipment will be the responsibility of the person who has determined its compatibility with the product. This person should also continuously review all specifications of the product referring to its latest catalog information, with a view to giving due consideration to any possibility of equipment failure when configuring the equipment.

2. Only personnel with appropriate training should operate machinery and equipment.

The product specified here may become unsafe if handled incorrectly. The assembly, operation and maintenance of machines or equipment including our products must be performed by an operator who is appropriately trained and experienced.

3. Do not service or attempt to remove product and machinery/equipment until safety is confirmed.

1. The inspection and maintenance of machinery/equipment should only be performed after measures to prevent falling or runaway of the driven objects have been confirmed.
2. When the product is to be removed, confirm that the safety measures as mentioned above are implemented and the power from any appropriate source is cut, and read and understand the specific product precautions of all relevant products carefully.
3. Before machinery/equipment is restarted, take measures to prevent unexpected operation and malfunction.

4. SMC products cannot be used beyond their specifications. They are not developed, designed, and manufactured to be used under the following conditions or environments. Use under such conditions or environments is not allowed.

1. Conditions and environments outside of the given specifications, or use outdoors or in a place exposed to direct sunlight.
2. Use for nuclear power, railways, aviation, space equipment, ships, vehicles, military application, equipment affecting human life, body, and property, combustion equipment, entertainment equipment, emergency shut-off circuits, press clutches, brake circuits, safety equipment, etc., and use for applications that do not conform to standard specifications such as catalogs and operation manuals.
3. Use for interlock circuits, except for use with double interlock such as installing a mechanical protection function in case of failure. Please periodically inspect the product to confirm that the product is operating properly.

Caution

SMC develops, designs, and manufactures products to be used for automatic control equipment, and provides them for peaceful use in manufacturing industries.

Use in non-manufacturing industries is not allowed.

Products SMC manufactures and sells cannot be used for the purpose of transactions or certification specified in the Measurement Act of each country. The new Measurement Act prohibits use of any unit other than SI units in Japan.

Limited warranty and Disclaimer/ Compliance Requirements

The product used is subject to the following “Limited warranty and Disclaimer” and “Compliance Requirements”.

Read and accept them before using the product.

Limited warranty and Disclaimer

1. The warranty period of the product is 1 year in service or 1.5 years after the product is delivered, whichever is first.*2)
Also, the product may have specified durability, running distance or replacement parts. Please consult your nearest sales branch.
2. For any failure or damage reported within the warranty period which is clearly our responsibility, a replacement product or necessary parts will be provided.
This limited warranty applies only to our product independently, and not to any other damage incurred due to the failure of the product.
3. Prior to using SMC products, please read and understand the warranty terms and disclaimers noted in the specified catalog for the particular products.

*2) **Suction cups (Vacuum pads) are excluded from this 1 year warranty.**

A suction cup (vacuum pad) is a consumable part, so it is warranted for a year after it is delivered.

Also, even within the warranty period, the wear of a product due to the use of the suction cup (vacuum pad) or failure due to the deterioration of rubber material are not allowed by the limited warranty.

Compliance Requirements

1. The use of SMC products with production equipment for the manufacture of weapons of mass destruction (WMD) or any other weapon is strictly prohibited.
2. The exports of SMC products or technology from one country to another are governed by the relevant security laws and regulations of the countries involved in the transaction. Prior to the shipment of a SMC product to another country, assure that all local rules governing that export are known and followed.

Safety Instructions

Be sure to read the “Handling Precautions for SMC Products” (M-E03-3) and “Operation Manual” before use.