

Models to accommodate
a wide variety of applications



Electric Actuators



For details, order the general
catalog for electric actuators
CAT. E101.

Two types of guide and three types of feed screw

Single Axis Electric Actuator Series **LJ1**



High rigidity

High rigidity achieved by the use of a hollow box type aluminum construction

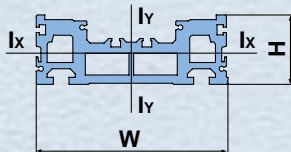

Model	Sectional secondary moment		W	H	
	lx	ly			
Linear guide	LJ1H10□□	7	48	70	24.7
	LJ1H20□□	40	374	122	44.8
	LJ1H30□□	84	836	151	55
Slider guide	LJ1S10□□	15	52	70	36
	LJ1S20□□	60	402	122	56.3
	LJ1S30□□	177	1000	151	73.3

High

Positioning accuracy

Low

• Work load

Slider guide	5 to 20kg
High rigidity direct acting guide	10 to 60kg

• Positioning repeatability

Slide screw	±0.1mm
Rolled ball screw	±0.05mm
Ground ball screw	±0.02mm

LJ1H
High rigidity
direct acting guide
+
Ground
ball screw

LJ1H
High rigidity
direct acting guide
+
Rolled
ball screw

LJ1S
Slider guide
+
Slide screw

LJ1H
High rigidity
direct acting guide
+
Slide screw

Low Work load/Allowable moment High

Low noise (slide screw type)

Slide screw + Slider guide: **47dB** (LJ1S)

Slide screw + Linear guide: **53dB** (LJ1H)

Low profile/non-coupling type with reduced height and length

Low Profile Electric Actuator Series **LG1**

Series with coupling available

Mounting of a non-standard motor is possible.

Low profile: **55mm** (35mm less than LJ1H20)



Reduced length (62mm shorter than LJ1H20 with coupling and 300mm stroke)



Controller
Series **LC1**



Teaching box



Regenerative
absorption unit
Series **LC7R**



Short stroke type with three guide variations

Short Stroke Electric Actuators

Series LX

Low profile slide table type with stepper motor

Series LXF

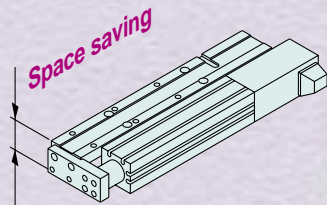

Thickness: 31mm

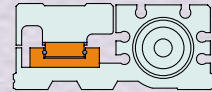

Guide rod type with stepper motor

Series LXP

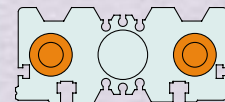
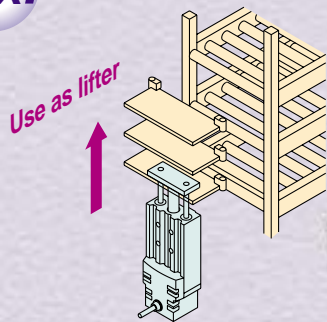

High rigidity slide table type with stepper motor

Series LXS

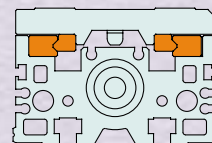
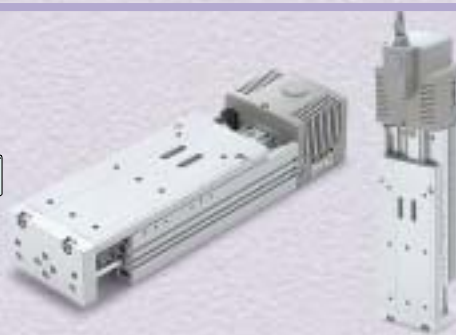
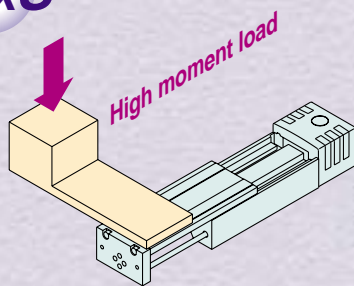

AC servomotor specification/Order made

CE marking available as standard

Series LXF

Series LXP

Series LXS



Driver

Series LC6D



Positioning driver

Series LC6C





Teaching box





Simplified Selection Flow Chart

Single Axis Electric Actuator *Series LJ1* (AC Servomotor)

Series	Clean room	Dust seal	Brake	Work load kg	Maximum speed mm/s	Positioning repeatability mm	Lead screw	Guide type
Horizontal mount specification Series LJ1 			Without brake	5	300	±0.1	Slide screw	Slider guide
						300		
				10	500	±0.1	Ground ball screw	High rigidity direct acting guide
						600		
				15	500	±0.1	Slide screw	Slider guide
				20	300	±0.1		
				30		±0.02	Ground ball screw	High rigidity direct acting guide
						±0.05	Rolled ball screw	
						±0.1	Slide screw	
						±0.02	Ground ball screw	
						±0.05	Rolled ball screw	
						±0.02	Ground ball screw	
		60	1000	±0.02	Ground ball screw			
				±0.05	Rolled ball screw			
Vertical mount specification Series LJ1 			With brake	5	400	±0.02	Ground ball screw	High rigidity direct acting guide
						±0.05	Rolled ball screw	
				8	250	±0.02	Ground ball screw	
						±0.05	Rolled ball screw	
				10	600	±0.02	Ground ball screw	
						±0.05	Rolled ball screw	
				15	500	±0.02	Ground ball screw	
						±0.05	Rolled ball screw	
				20	500	±0.02	Ground ball screw	
						±0.05	Rolled ball screw	

Low Profile Single Axis Electric Actuator *Series LG1* (AC Servomotor)

Series	Clean room	Dust seal	Brake	Work load kg	Maximum speed mm/s	Positioning repeatability mm	Lead screw	Guide type
Without coupling/Horizontal mount specification Series LG1 	—	—	Without brake	15	500	±0.1	Slide screw	High rigidity direct acting guide
	—	—				±0.02	Ground ball screw	
	—	—				±0.05	Rolled ball screw	
	—	—		30	500	±0.02	Ground ball screw	
	—	—				±0.05	Rolled ball screw	
With coupling/Horizontal mount specification Series LG1 	—	—	Without brake	15	500	±0.1	Slide screw	High rigidity direct acting guide
	—	—				±0.02	Ground ball screw	
	—	—				±0.05	Rolled ball screw	
	—	—		30	500	±0.02	Ground ball screw	
	—	—				±0.05	Rolled ball screw	
				±0.02	Ground ball screw			
				±0.05	Rolled ball screw			





Simplified Selection Flow Chart *Series LJ1/LG1*

Motor type	Capacity	Standard stroke (mm) and Speed (mm/s)											Model		
		100	200	300	400	500	600	700	800	900	1000	1200		1500	
Standard motor [Tamagawa Seiki Co., Ltd.] Non-standard motor [Matsushita Electric Industrial Co., Ltd.] [Mitsubishi Electric Corporation] [Yaskawa Electric Corporation]	50W	to 300													LJ1S101□SC
	100W	to 300													LJ1S202□SC
	50W	to 500													LJ1H101□SC
	50W	to 600													LJ1H101□PB
	50W	to 600													LJ1H101□NB
	100W	to 500													LJ1H202□SC
	200W	to 500						to 500			to 500				LJ1S303□SC
	100W	to 500													LJ1H202□PA
	100W	to 500													LJ1H202□NA
	200W	to 500						to 500		to 500					LJ1H303□SE
	100W				to 1000		to 930	to 740	to 600	to 500					LJ1H202□PC
	100W				to 1000		to 930	to 740	to 600	to 500					LJ1H202□NC
	200W	to 1000						to 1000		to 1000	to 700	to 500			LJ1H303□PD
	200W	to 1000						to 1000		to 1000	to 700	to 500			LJ1H303□ND
Standard motor [Tamagawa Seiki Co., Ltd.] Non-standard motor [Matsushita Electric Industrial Co., Ltd.] [Mitsubishi Electric Corporation] [Yaskawa Electric Corporation]	100W	to 400												LJ1H102□PH-□K	
	100W	to 400													LJ1H102□NH-□K
	100W	to 250													LJ1H202□PF-□K
	100W	to 250													LJ1H202□NF-□K
	100W	to 600													LJ1H102□PB-□K
	100W	to 600													LJ1H102□NB-□K
	100W	to 500													LJ1H202□PA-□K
	100W	to 500													LJ1H202□NA-□K
	200W	to 500													LJ1H303□PA-□K
	200W	to 500													LJ1H303□NA-□K





Motor type	Capacity	Standard stroke (mm) and Speed (mm/s)											Model		
		100	200	300	400	500	600	700	800	900	1000	1200		1500	
Standard motor [Tamagawa Seiki Co., Ltd.]	100W	to 500													LG1□H202□SC
	100W	to 500													LG1□H202□PA
	100W	to 500													LG1□H202□NA
	100W				to 1000		to 930	to 740	to 600	to 500					LG1□H202□PC
	100W				to 1000		to 930	to 740	to 600	to 500					LG1□H202□NC
Standard motor [Tamagawa Seiki Co., Ltd.] Non-standard motor [Matsushita Electric Industrial Co., Ltd.] [Mitsubishi Electric Corporation] [Yaskawa Electric Corporation]	100W	to 500												LG1□H212□SC	
	100W	to 500													LG1□H212□PA
	100W	to 500													LG1□H212□NA
	100W				to 1000		to 930	to 740	to 600	to 500					LG1□H212□PC
	100W				to 1000		to 930	to 740	to 600	to 500					LG1□H212□NC

Simplified Selection Flow Chart

Short Stroke Type Electric Actuator *Series LX* (Stepper Motor)

Series	Low particulate generation	Brake	Work load kg	Maximum speed mm/s	Positioning repeatability mm	Lead screw	Guide type
Flat table type Series LXF 	—	Without motor brake	2	200	±0.05	Slide screw	Direct acting guide
	●		3	30	±0.03	Ball screw	
	●			80	±0.05	Slide screw	
	—			100	±0.05	Slide screw	
Guide rod type Series LXP  	—	Without motor brake	2	200	±0.05	Slide screw	Ball bushing guide
	—		3	200			
	—		4	100			
	●		6	30	±0.03	Ball screw	
	●			80			
	●			100			
	—	With motor brake	2	200	±0.05	Slide screw	
	—		3	200			
	—		4	100			
	●		5	30	±0.03	Ball screw	
●	80						
—	100	±0.05	Slide screw				
Slide table type Series LXS  	—	Without motor brake	3	200	±0.05	Slide screw	High rigidity direct acting guide
	—		4.5	200			
	—		6	100			
	—		9	100			
	●		10	30	±0.03	Ball screw	
	●			80			
	—	With motor brake	1	200	±0.05	Slide screw	
	—		2	200			
	—		4	100			
	●		5	30	±0.03	Ball screw	
●	80						

Short Stroke Type Electric Actuator *Series LX* (AC Servomotor)

Series	Low particulate generation	Brake	Work load kg	Maximum speed mm/s	Positioning repeatability mm	Lead screw	Guide type
Series LXF 	—	Without motor brake	3	50	±0.03	Ball screw	Direct acting guide
	—			100			
Series LXP  	—	Without motor brake	6	50	±0.03	Ball screw	Ball bushing guide
	—			100			
	—	With motor brake	5	50			
Series LXS  	—	With motor brake	10	50	±0.03	Ball screw	High rigidity direct acting guide
	—			100			
	—	Without motor brake	5	50			
	—			100			

Simplified Selection Flow Chart *Series LX*

Motor		Standard stroke (mm) and Maximum speed (mm/s)								Model	
Manufacturer	Phases	25	50	75	100	125	150	175	200		
Sanyo Denki Co., Ltd.	5 phase	to 200									LXFH5SB
	5 phase	to 30									LXFH5BC
	5 phase	to 80									LXFH5BD
	5 phase	to 100									LXFH5SA
Sanyo Denki Co., Ltd.	5 phase	to 200								LXPB5SB	
	2 phase	to 200								LXPB2SB	
	5 phase	to 100								LXPB5SA	
	2 phase	to 30								LXPB2BC	
	5 phase	to 30								LXPB5BC	
	2 phase	to 80								LXPB2BD	
	5 phase	to 80								LXPB5BD	
	2 phase	to 100								LXPB2SA	
	5 phase	to 200								LXPB5SB-□B	
	2 phase	to 200								LXPB2SB-□B	
	5 phase	to 100								LXPB5SA-□B	
	2 phase	to 30								LXPB2BC-□B	
	5 phase	to 30								LXPB5BC-□B	
	2 phase	to 80								LXPB2BD-□B	
	5 phase	to 80								LXPB5BD-□B	
	2 phase	to 100								LXPB2SA-□B	
Sanyo Denki Co., Ltd.	5 phase	to 200								LXSH5SB	
	2 phase	to 200								LXSH2SB	
	5 phase	to 100								LXSH5SA	
	2 phase	to 100								LXSH2SA	
	5 phase	to 30								LXSH5BC	
	2 phase	to 30								LXSH2BC	
	5 phase	to 80								LXSH5BD	
	2 phase	to 80								LXSH2BD	
	5 phase	to 200								LXSH5SB-□B	
	2 phase	to 200								LXSH2SB-□B	
	5 phase	to 100								LXSH5SA-□B	
	2 phase	to 100								LXSH2SA-□B	
	5 phase	to 30								LXSH5BC-□B	
	2 phase	to 30								LXSH2BC-□B	
	5 phase	to 80								LXSH5BD-□B	
	2 phase	to 80								LXSH2BD-□B	

Motor		Standard stroke (mm) and Maximum speed (mm/s)								Model		
Manufacturer	Capacity	25	50	75	100	125	150	175	200			
Tamagawa Seiki Co., Ltd. Matsushita Electric Industrial Co., Ltd. Mitsubishi Electric Corporation Yaskawa Electric Corporation Note) Series LXF is only compatible with motors manufactured by Mitsubishi Electric Corporation.	30W	to 50									LXFHABC	
		to 100										LXFHABD
		to 50										LXPBABC
		to 100										LXPBABD
		to 50										LXPBABC-□B
		to 100										LXPBABD-□B
		to 50										LXSHABC
		to 100										LXSHABD
		to 50										LXSHABC-□B
		to 100										LXSHABD-□B

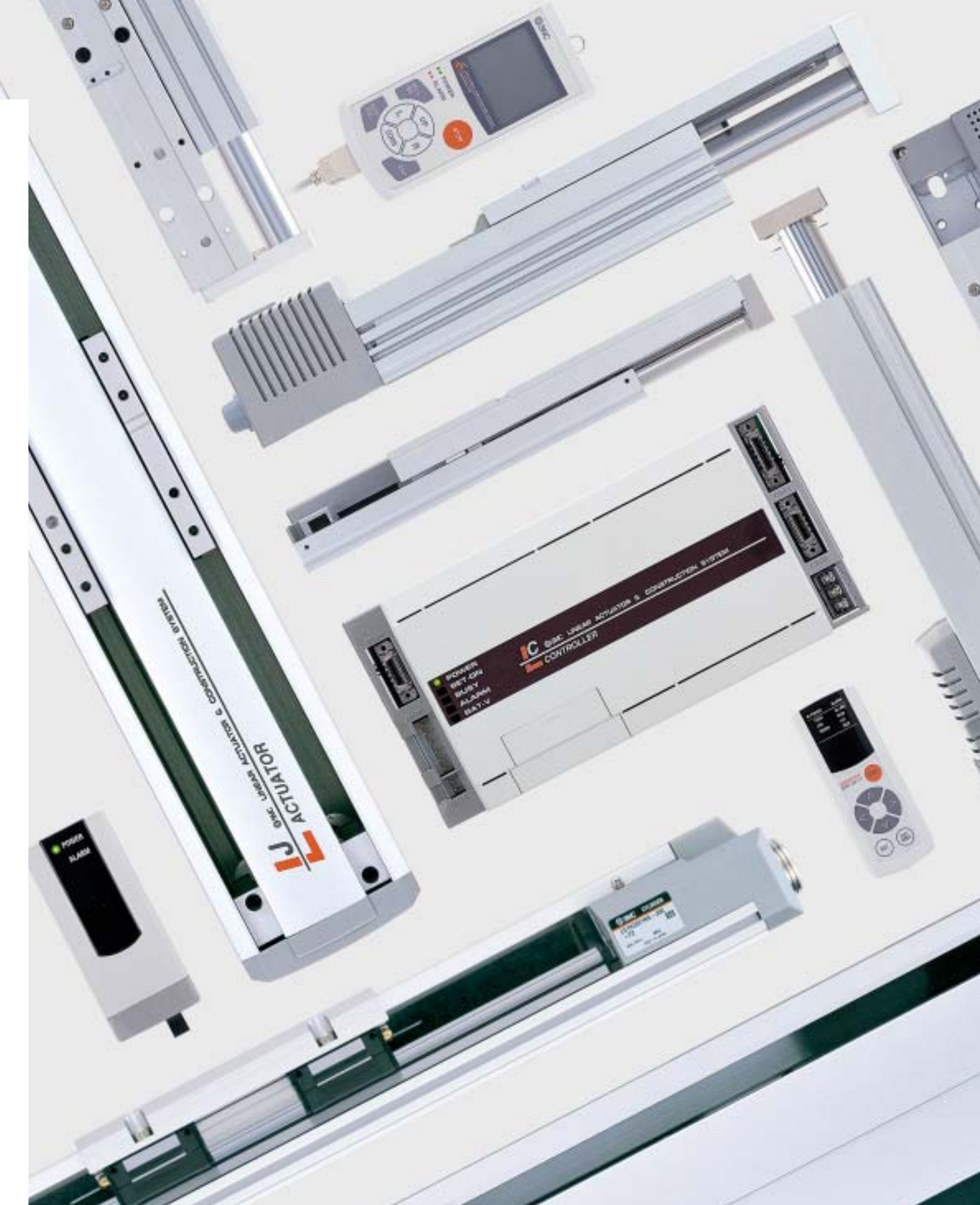

SMC CORPORATION

1-16-4 Shimbashi, Minato-ku, Tokyo 105-0004, JAPAN

Tel: 03-3502-2740 Fax: 03-3508-2480

URL <http://www.smcworld.com>

© 2000 SMC CORPORATION All Rights Reserved

1st printing September, 2000

D-SMC.L.A. P-80 (YG)

Specifications are subject to change without prior notice and any obligation on the part of the manufacturer.

Printed in Japan

This catalog is printed on recycled paper with concern for the global environment.