

Series CU

ø10, ø16, ø20, ø25, ø32

Construction

With auto switch

ø10

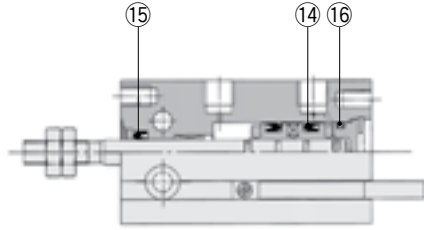
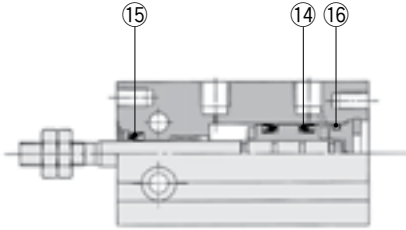

ø16 to ø32

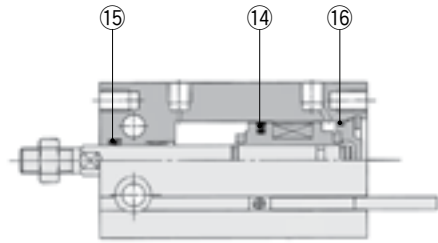
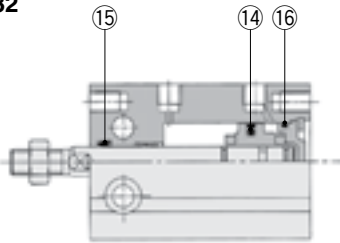

* The numbers are the same as the "Construction" of the Best Pneumatics No.2 Series CU.

Seal Kit List

No.	Description	Material	Note
14	Piston seal	NBR	
15	Rod seal		
16	Gasket		

*[BLUE](#) links will lead to purchase pages.

Replacement Parts: Seal Kit

Bore size (mm)	Kit no.	Contents
10	CU10D-PS	Set of left nos. 14, 15, 16.
16	CU16D-PS	
20	CU20D-PS	
25	CU25D-PS	
32	CU32D-PS	

* ø6 cannot be repaired.

* Seal kit includes 14, 15, 16. Order the seal kit, based on each bore size.

* Seal kit includes a grease pack (10 g).

Order with the following part number when only the grease pack is needed.

Grease pack part no.: GR-S-010 (10 g)

Actuators

Modular F.R.L.
Pressure Control Equipment

Air Preparation
Equipment

Industrial Filters

Replacement
Procedure

Actuators

Modular F.R.L.
Pressure Control Equipment

Industrial Filters

Series CU

ø10, ø16, ø20, ø25, ø32

Construction

Single acting, spring return

ø10

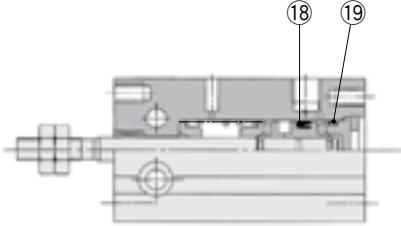

ø16 to ø32

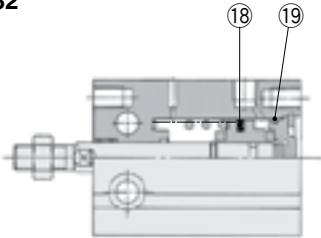

With auto switch

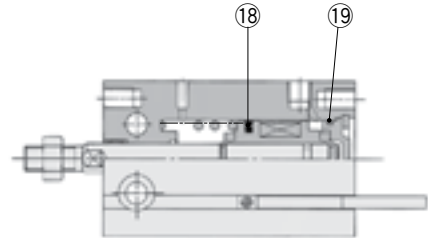
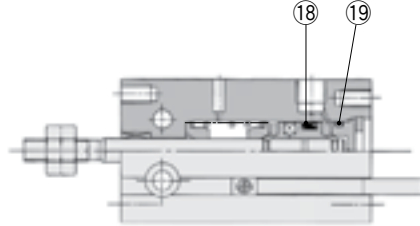

* The numbers are the same as the "Construction" of the Best Pneumatics No.2 Series CU.

Seal Kit List

No.	Description	Material	Note
18	Piston seal	NBR	
19	Gasket		

*[BLUE](#) links will lead to purchase pages.

Replacement Parts: Seal Kit

Bore size (mm)	Kit no.	Contents
10	CU10S-PS	Set of left nos. 18, 19.
16	CU16S-PS	
20	CU20S-PS	
25	CU25S-PS	
32	CU32S-PS	

* ø6 cannot be repaired.

* Seal kit includes 18, 19. Order the seal kit, based on each bore size.

* Seal kit includes a grease pack (10 g).

Order with the following part number when only the grease pack is needed.

Grease pack part no.: GR-S-010 (10 g)

Actuators

Modular F.R.L.
Pressure Control Equipment

Air Preparation
Equipment

Industrial Filters

Replacement
Procedure

Actuators

Modular F.R.L.
Pressure Control Equipment

Industrial Filters

Series CU

ø10, ø16, ø20, ø25, ø32

Construction

Single acting, spring extend

ø10

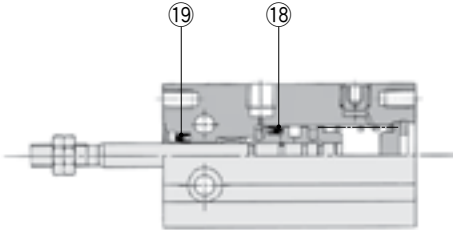

With auto switch

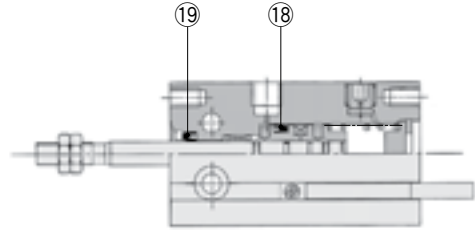

ø16 to ø32

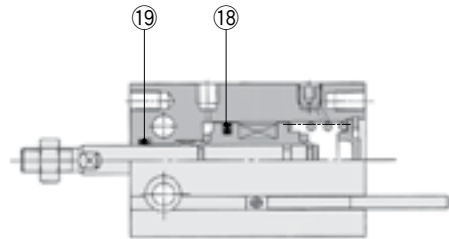
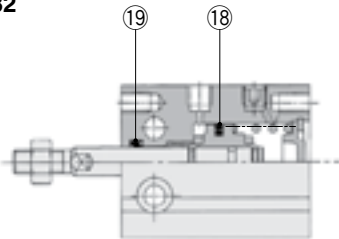

* The numbers are the same as the "Construction" of the Best Pneumatics No.2 Series CU.

Seal Kit List

No.	Description	Material	Note
18	Piston seal	NBR	
19	Rod seal		

*[BLUE](#) links will lead to purchase pages.

Replacement Parts: Seal Kit

Bore size (mm)	Kit no.	Contents
10	CU10T-PS	Set of left nos. 18, 19.
16	CU16T-PS	
20	CU20T-PS	
25	CU25T-PS	
32	CU32T-PS	

* ø6 cannot be repaired.

* Seal kit includes 18, 19. Order the seal kit, based on each bore size.

* Seal kit includes a grease pack (10 g).

Order with the following part number when only the grease pack is needed.

Grease pack part no.: GR-S-010 (10 g)

Series CU

ø10, ø16, ø20, ø25, ø32

Construction

With auto switch

ø10

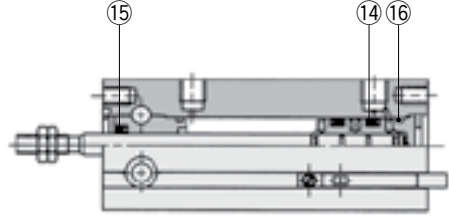
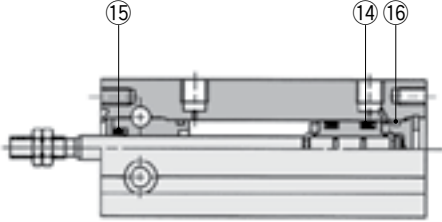

ø16 to ø32

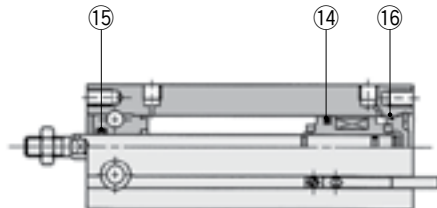
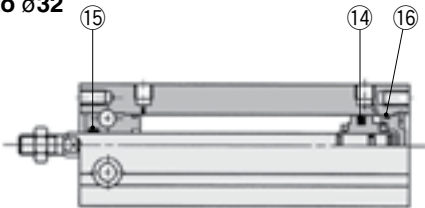

* The numbers are the same as the "Construction" of the Best Pneumatics No.2 Series CU.

Seal Kit List

No.	Description	Material	Note
14	Piston seal	NBR	
15	Rod seal		
16	Gasket		

*[BLUE](#) links will lead to purchase pages.

Replacement Parts: Seal Kit

Bore size (mm)	Kit no.	Contents
10	CU10D-PS	Set of left nos. 14, 15, 16.
16	CU16D-PS	
20	CU20D-PS	
25	CU25D-PS	
32	CU32D-PS	

* ø6 cannot be repaired.

* Seal kit includes 14, 15, 16. Order the seal kit, based on each bore size.

* Seal kit includes a grease pack (10 g).

Order with the following part number when only the grease pack is needed.

Grease pack part no.: GR-S-010 (10 g)

Actuators

Modular F.R.L.
Pressure Control Equipment

Air Preparation
Equipment

Industrial Filters

Replacement
Procedure

Actuators

Modular F.R.L.
Pressure Control Equipment

Industrial Filters

Series CU ø20, ø25, ø32

Construction

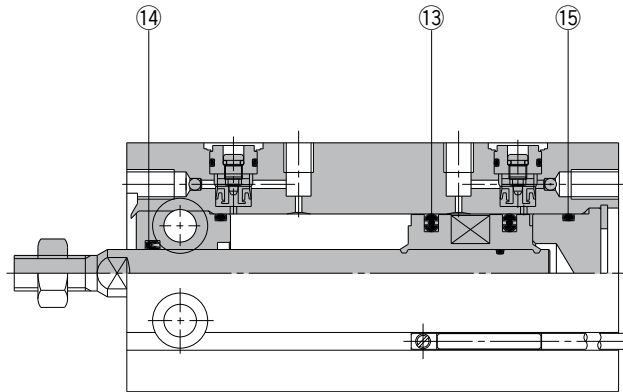

* The numbers are the same as the "Construction" of the Best Pneumatics No.2 Series CU.

Seal Kit List

No.	Description	Material	No. of pcs.	Note
13	Piston seal	NBR	2	
14	Rod seal		1	
15	Gasket		1	

*[BLUE](#) links will lead to purchase pages.

Replacement Parts: Seal Kit

Bore size (mm)	Kit no.	Contents
ø20	CU20A-PS	Set of left nos. 13, 14, 15.
ø25	CU25A-PS	
ø32	CU32A-PS	

* Seal kit includes 13, 14, 15. Order the seal kit, based on each bore size.

* Seal kit includes a grease pack (10 g).

Order with the following part number when only the grease pack is needed.

Grease pack part no.: GR-S-010 (10 g)